



This report provided free of charge by:

**King's Chariot**

14476 Duval Pl W Ste 305  
Jacksonville, FL 32218

(904) 419-7272



## Vehicle History Report™

US \$44.99

### 2008 LEXUS GX 470

VIN: JTJBT20X380156762  
4 DOOR WAGON/SPORT  
UTILITY  
4.7L V8 F DOHC 32V  
GASOLINE  
ALL WHEEL DRIVE

This CARFAX Report Provided  
by:  
**King's Chariot**



#### Damage reported: minor damage

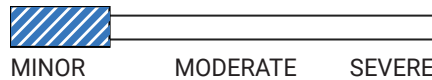

**11** Service history records



**3** Previous owners



Personal vehicle



**192,844** Last reported odometer reading

This CARFAX Vehicle History Report is based only on information supplied to CARFAX and available as of 7/10/24 at 12:08:04 PM (CDT). Other information about this vehicle, including problems, may not have been reported to CARFAX. Use this report as one important tool, along with a vehicle inspection and test drive, to make a better decision about your next used car.



### Accident / Damage History

Not all accidents / issues are reported to CARFAX

#### Event 1

11/16/2018

**Damage reported: minor damage**

#### Damage Severity Scale

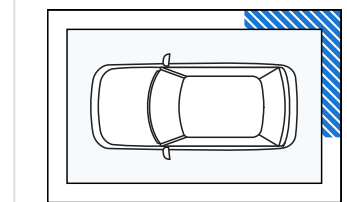
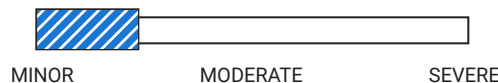

### Additional History

Not all accidents / issues are reported to CARFAX

Owner 1

Owner 2

Owner 3

<b>Total Loss</b> No total loss reported to CARFAX.	<input checked="" type="checkbox"/> No Issues Reported	<input checked="" type="checkbox"/> No Issues Reported	<input checked="" type="checkbox"/> No Issues Reported
<b>Structural Damage</b> CARFAX recommends that you have this vehicle inspected by a collision repair specialist.	<input checked="" type="checkbox"/> No Issues Reported	<input checked="" type="checkbox"/> No Issues Reported	<input checked="" type="checkbox"/> No Issues Reported
<b>Airbag Deployment</b> No airbag deployment reported to CARFAX.	<input checked="" type="checkbox"/> No Issues Reported	<input checked="" type="checkbox"/> No Issues Reported	<input checked="" type="checkbox"/> No Issues Reported
<b>Odometer Check</b> No indication of an odometer rollback.	<input checked="" type="checkbox"/> No Issues Indicated	<input checked="" type="checkbox"/> No Issues Indicated	<input checked="" type="checkbox"/> No Issues Indicated
<b>Accident / Damage</b> Damage reported: 11/16/2018.	<input checked="" type="checkbox"/> No Issues Reported	Minor Damage	No New Issues Reported
<b>Manufacturer Recall</b> No open recalls reported to CARFAX. Check with an authorized Lexus dealer for any open recalls. View Toyota disclosure	<input checked="" type="checkbox"/> No Recalls Reported	<input checked="" type="checkbox"/> No Recalls Reported	<input checked="" type="checkbox"/> No Recalls Reported

 <b>Title History</b> CARFAX guarantees the information in this section	Owner 1	Owner 2	Owner 3
<b>Damage Brands</b> Salvage   Junk   Rebuilt   Fire   Flood   Hail   Lemon	<input checked="" type="checkbox"/> <b>Guaranteed</b> No Problem	<input checked="" type="checkbox"/> <b>Guaranteed</b> No Problem	<input checked="" type="checkbox"/> <b>Guaranteed</b> No Problem
<b>Odometer Brands</b> Not Actual Mileage   Exceeds Mechanical Limits	<input checked="" type="checkbox"/> <b>Guaranteed</b> No Problem	<input checked="" type="checkbox"/> <b>Guaranteed</b> No Problem	<input checked="" type="checkbox"/> <b>Guaranteed</b> No Problem

 **GUARANTEED** - None of these title problems were reported by a U.S. state Department of Motor Vehicles (DMV). If you find that any of these title problems were reported by a DMV and not included in this report, you may qualify. [View Terms](#) | [View Certificate](#)

 <b>Ownership History</b> The number of owners is estimated	Owner 1	Owner 2	Owner 3
Year purchased	2008	2017	2021
Type of owner	Personal	Personal	Personal
Estimated length of ownership	8 yrs. 9 mo.	4 years	2 yrs. 10 mo.
Owned in the following states/provinces	Georgia	Georgia	Georgia
Estimated miles driven per year	15,287/yr	7,729/yr	---
Last reported odometer reading	101,276	151,906	192,844



## Detailed History





**Owner 1**



Purchased: 2008

Personal Vehicle

15,287 mi/yr

Date	Mileage	Source	Comments
12/18/2007		NICB	<b>Vehicle manufactured and shipped to Georgia</b>
12/28/2007	15	Johnson Lexus of Durham Raleigh, NC 919-433-8800 johnsonlexusdurham.com  ★ 4.8 / 5.0 1,460 Verified Reviews ♥ 13,039 Customer Favorites	 <b>Vehicle serviced</b> - Pre-delivery inspection completed - Nitrogen fill tires - Vehicle washed/detailed - Emissions or safety inspection performed
02/25/2008	20	Johnson Lexus of Durham Raleigh, NC 919-433-8800 johnsonlexusdurham.com  ★ 4.8 / 5.0 1,460 Verified Reviews ♥ 13,039 Customer Favorites	 <b>Vehicle serviced</b>
05/15/2008	2,468	Johnson Lexus of Durham Raleigh, NC 919-433-8800 johnsonlexusdurham.com  ★ 4.8 / 5.0 1,460 Verified Reviews ♥ 13,039 Customer Favorites	 <b>Vehicle serviced</b>
07/08/2008		Georgia Motor Vehicle Dept.	<b>Vehicle purchase reported</b> - Titled or registered as personal vehicle
07/25/2008	3,053	Georgia Motor Vehicle Dept. Clermont, GA	<b>Title issued or updated</b> - First owner reported - Loan or lien reported - Vehicle color noted as Green
10/21/2008		Georgia Motor Vehicle Dept. Clermont, GA	<b>Registration issued or renewed</b> - Vehicle color noted as Green

Clermont, GA

11/13/2009	Georgia Motor Vehicle Dept. Clermont, GA	<b>Registration issued or renewed</b> - Vehicle color noted as Green
11/11/2010	Georgia Motor Vehicle Dept. Clermont, GA	<b>Registration issued or renewed</b> - Vehicle color noted as Green
12/08/2011	Georgia Motor Vehicle Dept. Clermont, GA	<b>Registration issued or renewed</b> - Loan or lien reported - Vehicle color noted as Green
10/29/2012	Georgia Motor Vehicle Dept. Clermont, GA	<b>Registration issued or renewed</b> - Loan or lien reported - Vehicle color noted as Green
06/20/2013	78,544 Milton Martin Toyota Gainesville, GA 770-532-4355 miltonmartintoyota.com ★ 4.4 / 5.0 48 Verified Reviews	 <b>Vehicle serviced</b> - Brakes checked
12/31/2013	Georgia Motor Vehicle Dept. Clermont, GA	<b>Registration issued or renewed</b> - Loan or lien reported - Vehicle color noted as Green
05/15/2014	91,228 Milton Martin Toyota Gainesville, GA 770-532-4355 miltonmartintoyota.com ★ 4.4 / 5.0 48 Verified Reviews	 <b>Vehicle serviced</b> - Recommended maintenance performed - Water pump replaced - Drivability/performance checked - Body electrical system checked - Timing belt tensioner/idler checked - Engine/powertrain computer/module checked
10/30/2014	Georgia Motor Vehicle Dept. Clermont, GA	<b>Registration issued or renewed</b> - Loan or lien reported - Vehicle color noted as Green
02/20/2015	101,276 Milton Martin Toyota Gainesville, GA 770-532-4355 miltonmartintoyota.com ★ 4.4 / 5.0 48 Verified Reviews	 <b>Vehicle serviced</b> - Maintenance inspection completed - Oil and filter changed - Engine checked - Steering/suspension checked - Tires rotated - Radiator replaced - Cooling system checked
12/01/2015	Georgia Motor Vehicle Dept. Clermont, GA	<b>Registration issued or renewed</b> - Loan or lien reported - Vehicle color noted as Green

11/11/2016

Georgia  
Motor Vehicle Dept.  
Clermont, GA

**Registration issued or renewed**

- Title or registration issued
- Loan or lien reported
- Vehicle color noted as Green





**Owner 2**

Purchased: 2017



**Low mileage!** This owner drove less than the industry average of 15,000 miles per year.

Personal Vehicle  
7,729 mi/yr

Date	Mileage	Source	Comments
04/17/2017		Georgia Motor Vehicle Dept.	<b>Vehicle purchase reported</b>
04/24/2017	130,412	Georgia Motor Vehicle Dept. Clermont, GA	<b>Vehicle purchase reported</b> - Title issued or updated - New owner reported - Loan or lien reported - Vehicle color noted as Green
09/07/2017		Georgia Motor Vehicle Dept. Clermont, GA	<b>Registration issued or renewed</b> - Loan or lien reported - Vehicle color noted as Green
05/23/2018	139,180	John Megel Ford Cleveland, GA 706-865-2168 megelford.com/ ★ 4.7 / 5.0 258 Verified Reviews ❤️ 4,434 Customer Favorites	 <b>Vehicle serviced</b> - Maintenance inspection completed - Battery/charging system checked - Brakes checked - Oil and filter changed - Tires rotated - Tire condition and pressure checked
09/21/2018		Georgia Motor Vehicle Dept. Clermont, GA	<b>Registration issued or renewed</b> - Loan or lien reported - Vehicle color noted as Green
11/16/2018		Damage Report	 <b>Damage reported: minor damage</b> - Damage to rear - Damage to right rear

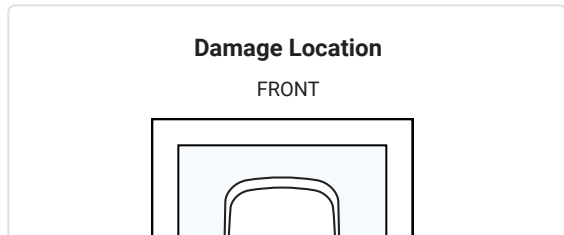
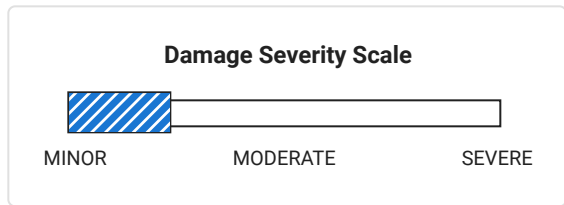

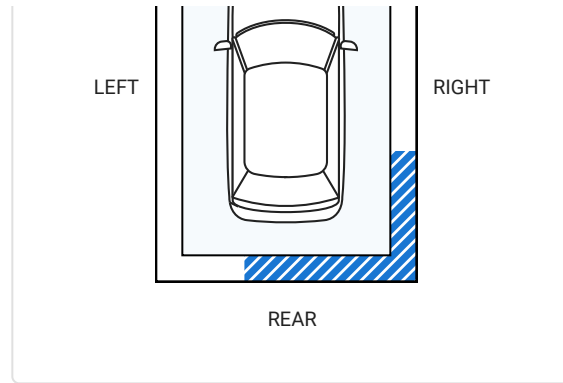

Minor damage is usually cosmetic, including dents or scratches to the vehicle body.

10/10/2019		Georgia Motor Vehicle Dept. Clermont, GA		<b>Registration issued or renewed</b> - Loan or lien reported - Vehicle color noted as Green
02/03/2020	151,906	Express Oil Change & Tire Engineers Dawsonville, GA 706-216-2032 <a href="https://expressoil.com/stores/dawsonville/ga/6067/">https://expressoil.com/stores/dawsonville/ga/6067/</a> ★ 4.8 / 5.0 358 Verified Reviews ❤️ 4,216 Customer Favorites		<b>Vehicle serviced</b> - Maintenance inspection completed - Light bulb(s) replaced - Fluids checked - Oil and filter changed - Antifreeze/coolant checked - Cooling system checked - Antifreeze/coolant flushed/changed
09/17/2020		Georgia Motor Vehicle Dept. Clermont, GA		<b>Registration issued or renewed</b> - Loan or lien reported - Vehicle color noted as Green



**Owner 3**  
Purchased: 2021

Personal Vehicle

Date	Mileage	Source	Comments
04/22/2021		Georgia Motor Vehicle Dept.	<b>Vehicle purchase reported</b> - Title issued or updated - New owner reported
09/03/2021		Georgia Motor Vehicle Dept. Clermont, GA	<b>Registration issued or renewed</b> - Vehicle color noted as Green
10/03/2022		Georgia Motor Vehicle Dept. Clermont, GA	<b>Registration issued or renewed</b> - Vehicle color noted as Green
07/29/2023	186,436	Valvoline Instant Oil	<b>Vehicle serviced</b>

Change  
Cleveland, GA  
706-865-0144  
vioc.com

★ 4.8 / 5.0

120 Verified Reviews

♥ 4 Customer Favorites



- Oil and filter changed
- Tires rotated
- Air filter replaced

08/23/2023

Georgia  
Motor Vehicle Dept.  
Clermont, GA

**Registration issued or renewed**

- Vehicle color noted as Green

03/06/2024 192,465

Mitchell County Ford  
Camilla, GA  
229-336-9002  
mitchellcountyford.com

★ 4.8 / 5.0

14 Verified Reviews

**Vehicle offered for sale**

03/12/2024 192,734

Flint River Ford  
Camilla, GA  
229-336-9002  
<https://flintriverford.com/>

★ 4.7 / 5.0

25 Verified Reviews



**Vehicle serviced**

- Pre-delivery inspection completed
- Hood shocks replaced
- Rear shock absorber(s) replaced
- Brakes replaced
- Tire(s) replaced
- Front axle(s) replaced/repared
- Valve cover gasket(s) replaced
- Brakes checked

03/14/2024

Online Listing

**Vehicle offered for sale**

03/25/2024

Mitchell County Ford  
Camilla, GA  
229-336-9002  
mitchellcountyford.com

★ 4.8 / 5.0

14 Verified Reviews

**Vehicle sold**

05/06/2024 192,844

Tubel's Service Center  
Jacksonville, FL  
904-757-8100  
tubelstireandservice.com  
/

★ 4.8 / 5.0

72 Verified Reviews

♥ 32 Customer Favorites



**Vehicle serviced**

- Alignment performed

06/06/2024

King's Chariot  
Jacksonville, FL  
904-419-7272  
kingschariot.web.auction  
123.com/

**Vehicle offered for sale**

07/10/2024

CARFAX Car Care

**Manufacturer Recommended**

## Maintenance Schedules



Get this vehicle's maintenance schedule, service history and recall alerts at [carfax.com/service](http://carfax.com/service).

Have Questions? Please visit our Help Center at [www.carfax.com](http://www.carfax.com).



## Glossary

### Damage Indicator

Damage can be a result of many different types of events. Examples include contact with objects (other cars, trees, traffic signs, road debris, etc), vandalism, or weather-related events. Not every damage event is reported to CARFAX. As details about the damage event become available, those additional details are added to the CARFAX Vehicle History Report. CARFAX recommends that you have this vehicle inspected by a qualified mechanic.

- This CARFAX Vehicle History Report is based only on information supplied to CARFAX and available as of 7/10/24 at 12:08:04 PM (CDT). Other information about this vehicle, including problems, may not have been reported to CARFAX. Use this report as one important tool, along with a vehicle inspection and test drive, to make a better decision about your next used car.

### Damage Severity

Damage events result in one of the following severity levels:

- Minor: Generally, minor damage is cosmetic (including dents or scratches), may only require reconditioning, and typically does not compromise a vehicle's operation and/or safety.
- Moderate: Moderate damage may affect multiple components of the vehicle and may impair the vehicle's operation and/or safety.
- Severe: Severe damage usually affects multiple components of the vehicle and is likely to compromise the vehicle's operation and/or safety.

CARFAX recommends getting a pre-purchase inspection at a certified collision repair facility.

### First Owner

When the first owner(s) obtains a title from a Department of Motor Vehicles as proof of ownership.

### Lexus Recall / Service Campaign

Portions of this report have been included under license from Toyota Motor North America, Inc. ("TOYOTA"), License Agreement TMS1013. This data applies only to vehicle marketed or originally sold in Mexico and the United States of America, including Guam, Saipan, American Samoa, Puerto Rico, the U.S. Virgin Islands and the other United States territories and protectorates with currently open safety or emissions recalls, or service campaigns. While TOYOTA provides data to Carfax Inc. on a regular basis, this report may not include very recent activity. For the manufacturer's most current information on recall/campaign activity for any Toyota, Lexus or Scion brand vehicle, you must go to <http://toyota.com/recall> or <http://lexus.com/recall>.

### New Owner Reported

When a vehicle is sold to a new owner, the Title must be transferred to the new owner(s) at a Department of Motor Vehicles.

### Ownership History

CARFAX defines an owner as an individual or business that possesses and uses a vehicle. Not all title transactions represent changes in ownership. To provide estimated number of owners, CARFAX proprietary technology analyzes all the events in a vehicle history. Estimated ownership is available for vehicles manufactured after 1991 and titled solely in the US including Puerto Rico. Dealers sometimes opt to take ownership of a vehicle and are required to in the following states: Maine, Massachusetts, New Jersey, Ohio, Oklahoma, Pennsylvania and South Dakota. Please consider this as you review a vehicle's estimated ownership history.

### Title Issued

A state issues a title to provide a vehicle owner with proof of ownership. Each title has a unique number. Each title or registration record on a CARFAX report does not necessarily indicate a change in ownership. In Canada, a



registration and bill of sale are used as proof of ownership.

**Follow Us:**



[facebook.com/CARFAX](https://www.facebook.com/CARFAX)



[@CARFAXinc](https://twitter.com/CARFAXinc)



[About CARFAX](#)

CARFAX DEPENDS ON ITS SOURCES FOR THE ACCURACY AND RELIABILITY OF ITS INFORMATION. THEREFORE, NO RESPONSIBILITY IS ASSUMED BY CARFAX OR ITS AGENTS FOR ERRORS OR OMISSIONS IN THIS REPORT. CARFAX FURTHER EXPRESSLY DISCLAIMS ALL WARRANTIES, EXPRESS OR IMPLIED, INCLUDING ANY IMPLIED WARRANTIES OF MERCHANTABILITY OR FITNESS FOR A PARTICULAR PURPOSE.

SYSTEMATIC RETRIEVAL OF THE CONTENT OR OTHER DATA FROM THIS SITE TO CREATE OR COMPILE, DIRECTLY OR INDIRECTLY, IN WHOLE OR IN PART, A COLLECTION, COMPILATION, DATABASE OR DIRECTORY WITHOUT THE EXPRESS WRITTEN PERMISSION OF CARFAX IS STRICTLY PROHIBITED. THE CARFAX VEHICLE HISTORY REPORT IS SUBJECT TO THE CARFAX.COM TERMS OF USE.

© 2024 CARFAX, Inc., part of S&P Global. All rights reserved.  
7/10/24 12:08:04 PM (CDT)