



This report provided free of charge by:

Exclusive Motors

2499 Arden Way
Sacramento, CA 95825

916-237-1307

★ **4.4 / 5.0**

22 Verified Reviews

♥ **2**

Customer Favorites



Vehicle History Report™

US \$44.99

2015 AUDI Q7 3.0 QUATTRO TDI PRESTIGE

VIN: WA1WMAFE5FD003558
4 DOOR WAGON/SPORT
UTILITY
3.0L V6 F DOHC 24V
DIESEL
ALL WHEEL DRIVE
This CARFAX Report Provided
by:

Exclusive Motors

★ **4.4 / 5.0**

22 Verified Reviews

♥ **2** Customer Favorites

Accident reported: minor damage

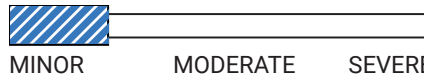

15 Service history records



2 Previous owners



Types of owners: Personal lease, Personal



134,080 Last reported odometer reading



This CARFAX Vehicle History Report is based only on information supplied to CARFAX and available as of 9/12/24 at 9:45:37 PM (CDT). Other information about this vehicle, including problems, may not have been reported to CARFAX. Use this report as one important tool, along with a vehicle inspection and test drive, to make a better decision about your next used car.



Accident / Damage History

Not all accidents / issues are reported to CARFAX

Event 1

09/13/2019

Accident reported: minor damage

- Vehicle involved in a rear-end collision with another motor vehicle
- Airbags did not deploy

Damage Severity Scale

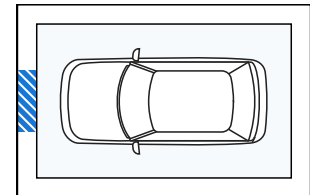
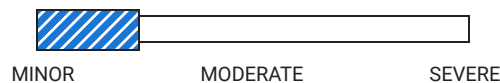

Event 2

05/20/2021

Damage reported: minor damage

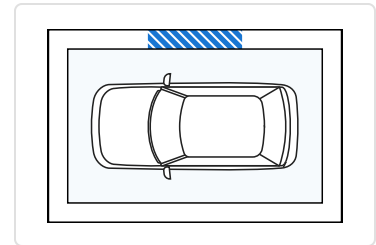
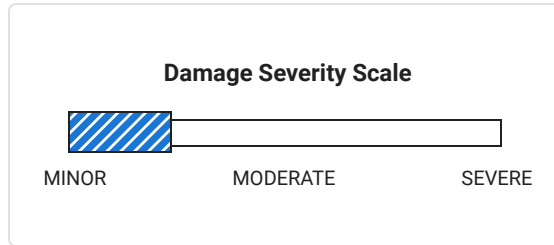

CARFAX Additional History Not all accidents / issues are reported to CARFAX	Owner 1	Owner 2
Total Loss No total loss reported to CARFAX.	✓ No Issues Reported	✓ No Issues Reported
Structural Damage CARFAX recommends that you have this vehicle inspected by a collision repair specialist.	✓ No Issues Reported	✓ No Issues Reported
Airbag Deployment No airbag deployment reported to CARFAX.	✓ No Issues Reported	✓ No Issues Reported
Odometer Check No indication of an odometer rollback.	✓ No Issues Indicated	✓ No Issues Indicated
Accident / Damage Accident reported: 09/13/2019. Damage reported: 05/20/2021.	✓ No Issues Reported	Minor Damage
Manufacturer Recall No open recalls reported to CARFAX.	✓ No Recalls Reported	✓ No Recalls Reported
Basic Warranty Original warranty estimated to have expired.	Warranty Expired	Warranty Expired

CARFAX Title History CARFAX guarantees the information in this section	Owner 1	Owner 2
Damage Brands Salvage Junk Rebuilt Fire Flood Hail Lemon	✓ Guaranteed No Problem	✓ Guaranteed No Problem
Odometer Brands Not Actual Mileage Exceeds Mechanical Limits	✓ Guaranteed No Problem	✓ Guaranteed No Problem



GUARANTEED - None of these title problems were reported by a U.S. state Department of Motor Vehicles (DMV). If you find that any of these title problems were reported by a DMV and not included in this report, you may qualify.
View Terms | View Certificate

CARFAX Ownership History The number of owners is estimated	Owner 1	Owner 2
--	---------	---------

Year purchased	2014	2019
Type of owner	Personal lease	Personal
Estimated length of ownership	4 yrs. 1 mo.	4 yrs. 6 mo.
Owned in the following states/provinces	California	California
Estimated miles driven per year	15,189/yr	14,143/yr
Last reported odometer reading	65,794	134,080



Detailed History



Owner 1
Purchased: 2014

Personal Lease
Vehicle
15,189 mi/yr

Date	Mileage	Source	Comments
08/21/2014		NICB	Vehicle manufactured and shipped to original dealer
08/21/2014	20	California Motor Vehicle Dept. Winters, CA	Odometer reading reported
08/27/2014	24	Niello Audi Sacramento, CA 916-480-2800 audi.niello.com ★ 4.6 / 5.0 152 Verified Reviews ♥ 2,924 Customer Favorites	Vehicle serviced - Pre-delivery inspection completed
09/05/2014		California Motor Vehicle Dept. Winters, CA	Title issued or updated - First owner reported - Titled or registered as personal lease vehicle - Loan or lien reported
10/29/2014	5,413	Niello Audi Sacramento, CA 916-480-2800 audi.niello.com ★ 4.6 / 5.0 152 Verified Reviews ♥ 2,924 Customer Favorites	Vehicle serviced - 5,000 mile service performed - Tire condition and pressure checked

04/29/2015	16,137	Niello Audi Sacramento, CA 916-480-2800 audi.niello.com		Vehicle serviced - 15,000 mile service performed - Tire condition and pressure checked
		★ 4.6 / 5.0 152 Verified Reviews ❤️ 2,924 Customer Favorites		
09/24/2015	27,886	Niello Audi Sacramento, CA 916-480-2800 audi.niello.com		Vehicle serviced - Maintenance inspection completed - 25,000 mile service performed - Tire condition and pressure checked - Brakes checked
		★ 4.6 / 5.0 152 Verified Reviews ❤️ 2,924 Customer Favorites		
12/29/2015	33,236	Niello Audi Sacramento, CA 916-480-2800 audi.niello.com		Vehicle serviced - Tire repaired - Tire condition and pressure checked - Battery/charging system checked - Battery replaced - Anti-theft/keyless remote battery replaced
		★ 4.6 / 5.0 152 Verified Reviews ❤️ 2,924 Customer Favorites		
03/14/2016	37,737	Niello Audi Sacramento, CA 916-480-2800 audi.niello.com		Vehicle serviced - Maintenance inspection completed - 35,000 mile service performed - Tire condition and pressure checked - Brake fluid flushed/changed - Interior trim checked - Anti-theft/keyless remote battery replaced - Sunroof serviced
		★ 4.6 / 5.0 152 Verified Reviews ❤️ 2,924 Customer Favorites		
11/14/2016	51,693	Niello Audi Sacramento, CA 916-480-2800 audi.niello.com		Vehicle serviced - Maintenance inspection completed - 45,000 mile service performed - Tire condition and pressure checked - Brakes checked - Electrical system checked
		★ 4.6 / 5.0 152 Verified Reviews ❤️ 2,924 Customer Favorites		
10/15/2018	62,466	Auto Auction	Vehicle sold	
			Millions of used vehicles are bought and sold at auction every year.	
11/23/2018	62,671	Hyundai Serramonte Colma, CA	Vehicle offered for sale	

650-550-7250
 hyundaiserramonte.com/
 ★ 4.0 / 5.0
 44 Verified Reviews

01/01/2019	Hyundai Serramonte Colma, CA 650-550-7250 hyundaiserramonte.com/ ★ 4.0 / 5.0 44 Verified Reviews	Vehicle sold
02/28/2019 65,794	DAS Auto Service DALY CITY, CA 650-731-8500 ★ 4.9 / 5.0 36 Verified Reviews ♥ 23 Customer Favorites	 Vehicle serviced - Emissions inspection performed
02/28/2019	California Inspection Station	Passed emissions inspection





Owner 2
Purchased: 2019



Low mileage! This owner drove less than the industry average of 15,000 miles per year.

Personal Vehicle
14,143 mi/yr

Date	Mileage	Source	Comments
03/26/2019		California Motor Vehicle Dept. Daly City, CA	Title issued or updated - New owner reported - Loan or lien reported
06/24/2019 70,298		Hyundai Serramonte Colma, CA 650-550-7250 hyundaiserramonte.com/ ★ 4.0 / 5.0 44 Verified Reviews	 Vehicle serviced - Maintenance inspection completed - Brakes checked - Tire condition and pressure checked
09/13/2019		Damage Report	 Accident reported: minor damage - Vehicle involved in a rear-end collision with another motor vehicle - Damage to front - Airbags did not deploy

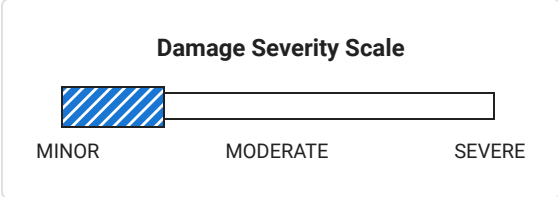



Damage Location

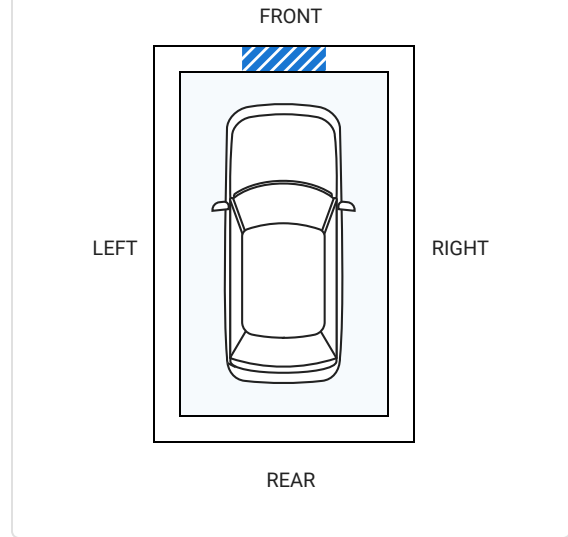

Minor damage is usually cosmetic, including dents or scratches to the vehicle body.

08/11/2020 83,655 California Inspection Station

Passed emissions inspection

05/20/2021 Damage Report

i **Damage reported: minor damage**
- Damage to right side

Damage Severity Scale

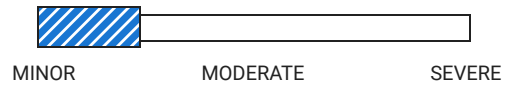

Damage Location

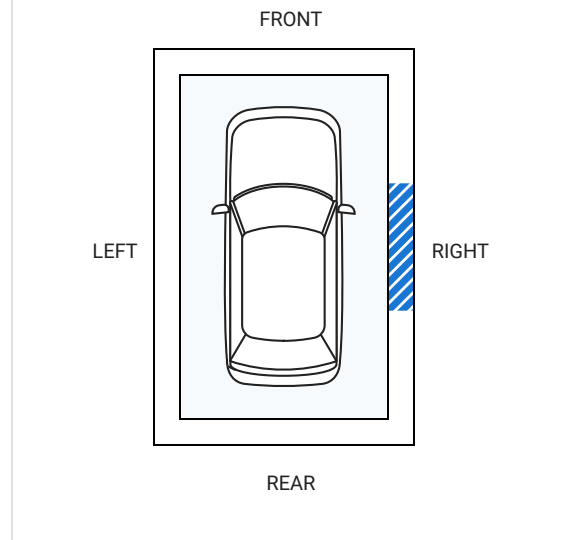





Minor damage is usually cosmetic, including dents or scratches to the vehicle body.

02/20/2022	112,486	Mission Tire and Services San Francisco, CA 415-285-9800 carcare-2u.com ★ 4.1 / 5.0 39 Verified Reviews		Vehicle serviced - Oil and filter changed
08/31/2022	116,140	California Inspection Station		Passed emissions inspection
10/03/2023		Online Listing		Vehicle offered for sale
10/10/2023		Auto Auction		Vehicle sold
10/11/2023	131,133	Steven's Creek Lincoln San Jose, CA 408-984-2001 sclincoln.com ★ 4.9 / 5.0 30 Verified Reviews ♥ 309 Customer Favorites		Vehicle sold
10/26/2023	131,660	California Inspection Station		Passed emissions inspection
10/31/2023	131,670	Niello Audi Sacramento, CA 916-480-2800 audi.niello.com ★ 4.6 / 5.0 152 Verified Reviews ♥ 2,924 Customer Favorites		Vehicle serviced - Tire(s) mounted
11/02/2023		Exclusive Motors Sacramento, CA 916-624-4700 exclusivemotors4u.com ★ 4.4 / 5.0 22 Verified Reviews ♥ 2 Customer Favorites		Vehicle serviced - Air filter replaced - Dash trim panel replaced/repared - Brakes checked - Wiper(s) replaced - Brake pads replaced - Brake pad sensor(s) replaced - Oil and filter changed - Antifreeze/coolant checked - Brake fluid flushed/changed - Front brake rotor(s) replaced - Front brake pads replaced - Antifreeze/coolant flushed/changed - Cabin air filter replaced/cleaned

01/12/2024 132,658 Exclusive Motors
 Sacramento, CA
 916-624-4700
 exclusivemotors4u.com
 ★ 4.4 / 5.0
 22 Verified Reviews
 ❤️ 2 Customer Favorites

 **Vehicle serviced**
 - Headliner replaced
 - Upper control arm(s) replaced
 - Roof rack installed

01/26/2024 133,230 Exclusive Motors
 Sacramento, CA
 916-624-4700
 exclusivemotors4u.com
 ★ 4.4 / 5.0
 22 Verified Reviews
 ❤️ 2 Customer Favorites

 **Vehicle serviced**
 - Computer(s) checked



Looks like this dealer serviced the car in order to prepare it for sale. That's a good thing!

02/01/2024 Exclusive Motors
 Sacramento, CA
 916-624-4700
 exclusivemotors4u.com
 ★ 4.4 / 5.0
 22 Verified Reviews
 ❤️ 2 Customer Favorites

Vehicle offered for sale

03/22/2024 134,080 Exclusive Motors
 Sacramento, CA
 916-624-4700
 exclusivemotors4u.com
 ★ 4.4 / 5.0
 22 Verified Reviews
 ❤️ 2 Customer Favorites

 **Vehicle serviced**
 - Intake manifold gasket(s) replaced
 - Oil and filter changed
 - Thermostat replaced
 - Oil pump seal replaced
 - EGR system checked
 - Engine oil/fluid leak checked
 - Throttle body cleaned/serviced
 - Seatbelts checked
 - Engine oil cooler replaced/repared
 - Turbocharger checked

09/12/2024 CARFAX Car Care

Manufacturer Recommended Maintenance Schedules



Get this vehicle's maintenance schedule, service history and recall alerts at [carfax.com/service](https://www.carfax.com/service).

Have Questions? Please visit our Help Center at www.carfax.com.



Glossary

Accident Indicator

CARFAX receives information about accidents in all 50 states, the District of Columbia and Canada.

Not every accident is reported to CARFAX. As details about the accident become available, those additional details are added to the CARFAX Vehicle History Report. CARFAX recommends that you have this vehicle inspected by a qualified mechanic.

- According to the National Safety Council, Injury Facts, 2021 edition, 5% of the 276 million registered vehicles in the U.S. were involved in an accident in 2019. Over 77% of these were considered minor or moderate.
- This CARFAX Vehicle History Report is based only on information supplied to CARFAX and available as of 9/12/24 at 9:45:37 PM (CDT). Other information about this vehicle, including problems, may not have been reported to CARFAX. Use this report as one important tool, along with a vehicle inspection and test drive, to make a better decision about your next used car.

Damage Indicator

Damage can be a result of many different types of events. Examples include contact with objects (other cars, trees, traffic signs, road debris, etc), vandalism, or weather-related events. Not every damage event is reported to CARFAX. As details about the damage event become available, those additional details are added to the CARFAX Vehicle History Report. CARFAX recommends that you have this vehicle inspected by a qualified mechanic.

- This CARFAX Vehicle History Report is based only on information supplied to CARFAX and available as of 9/12/24 at 9:45:37 PM (CDT). Other information about this vehicle, including problems, may not have been reported to CARFAX. Use this report as one important tool, along with a vehicle inspection and test drive, to make a better decision about your next used car.

Damage Severity

Damage events result in one of the following severity levels:

- Minor: Generally, minor damage is cosmetic (including dents or scratches), may only require reconditioning, and typically does not compromise a vehicle's operation and/or safety.
- Moderate: Moderate damage may affect multiple components of the vehicle and may impair the vehicle's operation and/or safety.
- Severe: Severe damage usually affects multiple components of the vehicle and is likely to compromise the vehicle's operation and/or safety.

CARFAX recommends getting a pre-purchase inspection at a certified collision repair facility.

First Owner

When the first owner(s) obtains a title from a Department of Motor Vehicles as proof of ownership.

New Owner Reported

When a vehicle is sold to a new owner, the Title must be transferred to the new owner(s) at a Department of Motor Vehicles.

Ownership History

CARFAX defines an owner as an individual or business that possesses and uses a vehicle. Not all title transactions represent changes in ownership. To provide estimated number of owners, CARFAX proprietary technology analyzes all the events in a vehicle history. Estimated ownership is available for vehicles manufactured after 1991 and titled solely in the US including Puerto Rico. Dealers sometimes opt to take ownership of a vehicle and are required to in the following states: Maine, Massachusetts, New Jersey, Ohio, Oklahoma, Pennsylvania and South Dakota. Please consider this as you review a vehicle's estimated ownership history.

Title Issued

A state issues a title to provide a vehicle owner with proof of ownership. Each title has a unique number. Each title or registration record on a CARFAX report does not necessarily indicate a change in ownership. In Canada, a registration and bill of sale are used as proof of ownership.

CARFAX DEPENDS ON ITS SOURCES FOR THE ACCURACY AND RELIABILITY OF ITS INFORMATION. THEREFORE, NO RESPONSIBILITY IS ASSUMED BY CARFAX OR ITS AGENTS FOR ERRORS OR OMISSIONS IN THIS REPORT. CARFAX FURTHER EXPRESSLY DISCLAIMS ALL WARRANTIES, EXPRESS OR IMPLIED, INCLUDING ANY IMPLIED WARRANTIES OF MERCHANTABILITY OR FITNESS FOR A PARTICULAR PURPOSE.

SYSTEMATIC RETRIEVAL OF THE CONTENT OR OTHER DATA FROM THIS SITE TO CREATE OR COMPILE, DIRECTLY OR INDIRECTLY, IN WHOLE OR IN PART, A COLLECTION, COMPILATION, DATABASE OR DIRECTORY WITHOUT THE EXPRESS WRITTEN PERMISSION OF CARFAX IS STRICTLY PROHIBITED. BY USING THE CARFAX VEHICLE HISTORY REPORT YOU AGREE TO THE CARFAX TERMS OF USE AND PRIVACY STATEMENT.

© 2024 CARFAX, Inc., part of S&P Global. All rights reserved.

9/12/24 9:45:37 PM (CDT)