



This report provided free of charge by:

**Frankman Motor Co., Inc.**

26874 SD Highway 11  
Sioux Falls, SD 57108

605-210-6165

★ **4.7 / 5.0**  
115 Verified Reviews

♥ **63**  
Customer Favorites



## Vehicle History Report™

US \$44.99

### 1985 DODGE RAM VAN B250

VIN: 2B4HB21W6FK221652

VAN

5.9L V8 4BL

GASOLINE

REAR WHEEL DRIVE

This CARFAX Report Provided  
by:

**Frankman Motor Co., Inc.**

★ **4.7 / 5.0**

115 Verified Reviews

♥ **63** Customer Favorites



Branded Title: Not Actual Mileage

#### Accident reported: minor damage

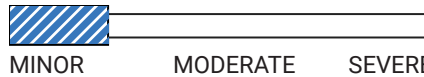

**1** Service history record



**25** Detailed records available



This CARFAX Vehicle History Report is based only on information supplied to CARFAX and available as of 11/28/24 at 12:25:12 PM (CST). Other information about this vehicle, including problems, may not have been reported to CARFAX. Use this report as one important tool, along with a vehicle inspection and test drive, to make a better decision about your next used car.



### Accident / Damage History

Not all accidents / issues are reported to CARFAX

#### Event 1

06/23/2008

**Accident reported:  
minor damage**

- Vehicle ran off road

#### Damage Severity Scale

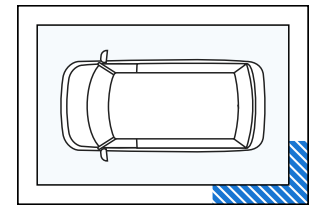
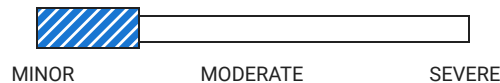



 <b>Additional History</b> Not all accidents / issues are reported to CARFAX	Summary
<b>Total Loss</b> No total loss reported to CARFAX.	<input checked="" type="checkbox"/> No Issues Reported
<b>Structural Damage</b> CARFAX recommends that you have this vehicle inspected by a collision repair specialist.	<input checked="" type="checkbox"/> No Issues Reported
<b>Airbag Deployment</b> No airbag deployment reported to CARFAX.	<input checked="" type="checkbox"/> No Issues Reported
<b>Odometer Check</b> DMV title problems reported.	Odometer Problem
<b>Accident / Damage</b> Accident reported: 06/23/2008.	Minor Damage
<b>Manufacturer Recall</b> Check with an authorized Dodge dealer for any open recalls.	<input checked="" type="checkbox"/> No Recalls Reported
<b>Basic Warranty</b> No data reported to CARFAX.	No Data Reported

 <b>Title History</b>	Summary
<b>Damage Brands</b> Salvage   Junk   Rebuilt   Fire   Flood   Hail   Lemon	No Problem
<b>Odometer Brands</b> Not Actual Mileage   Exceeds Mechanical Limits	<b>Alert!</b> <b>Problem Found</b>



**ALERT!** - Severe problems were reported by a state Department of Motor Vehicles (DMV). This vehicle does not qualify for the CARFAX Buyback Guarantee.

 <b>Detailed History</b>			
Date	Mileage	Source	Comments
10/24/1984		Iowa Motor Vehicle Dept. Milford, IA	<b>Title issued or updated</b> - First owner reported
03/01/1999		Iowa Motor Vehicle Dept. Spencer, IA	<b>Title issued or updated</b>
10/12/2005		Iowa Motor Vehicle Dept.	 <b>NOT ACTUAL MILEAGE TITLE ISSUED</b> - Vehicle color noted as Cream

Spencer, IA



A NAM title is issued when the owner discloses to a DMV mileage fraud, a broken odometer or that the actual mileage of this vehicle is unknown. Mileage reported after this reading is potentially unreliable.

10/03/2006

Iowa  
Motor Vehicle Dept.  
Spencer, IA



**NOT ACTUAL MILEAGE TITLE ISSUED**  
- Vehicle color noted as Cream

10/10/2007

Iowa  
Motor Vehicle Dept.  
Spencer, IA



**NOT ACTUAL MILEAGE TITLE ISSUED**  
- Vehicle color noted as Cream

06/23/2008

Damage Report



**Accident reported: minor damage**  
- Vehicle ran off road  
- Damage to left rear

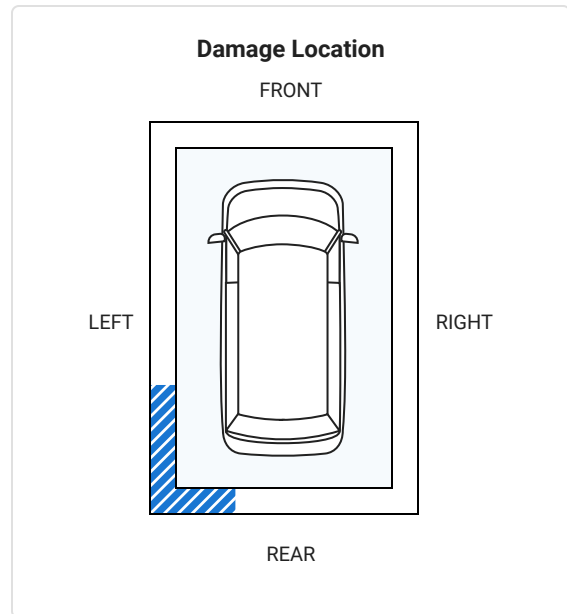
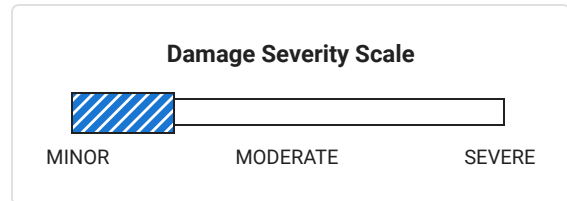













Minor damage is usually cosmetic, including dents or scratches to the vehicle body.



09/30/2008

Iowa  
Motor Vehicle Dept.  
Spencer, IA



**NOT ACTUAL MILEAGE TITLE ISSUED**  
- Vehicle color noted as Cream

10/01/2009	Iowa Motor Vehicle Dept. Spencer, IA	 <b>NOT ACTUAL MILEAGE TITLE ISSUED</b> - Vehicle color noted as Cream
10/05/2010	Iowa Motor Vehicle Dept. Spencer, IA	 <b>NOT ACTUAL MILEAGE TITLE ISSUED</b> - Vehicle color noted as Cream
10/17/2011	Iowa Motor Vehicle Dept. Spencer, IA	 <b>NOT ACTUAL MILEAGE TITLE ISSUED</b> - Vehicle color noted as Cream
10/05/2012	Iowa Motor Vehicle Dept. Spencer, IA	 <b>NOT ACTUAL MILEAGE TITLE ISSUED</b> - Vehicle color noted as Cream
10/08/2013	Iowa Motor Vehicle Dept. Spencer, IA	 <b>NOT ACTUAL MILEAGE TITLE ISSUED</b> - Vehicle color noted as Cream
10/15/2014	Iowa Motor Vehicle Dept. Spencer, IA	 <b>NOT ACTUAL MILEAGE TITLE ISSUED</b> - Vehicle color noted as Cream
10/09/2015	Iowa Motor Vehicle Dept. Spencer, IA	 <b>NOT ACTUAL MILEAGE TITLE ISSUED</b> - Vehicle color noted as Cream
10/11/2016	Iowa Motor Vehicle Dept. Spencer, IA	 <b>NOT ACTUAL MILEAGE TITLE ISSUED</b> - Vehicle color noted as Cream
10/17/2017	Iowa Motor Vehicle Dept. Spencer, IA	 <b>NOT ACTUAL MILEAGE TITLE ISSUED</b> - Vehicle color noted as Cream
10/24/2018	Iowa Motor Vehicle Dept. Spencer, IA	 <b>NOT ACTUAL MILEAGE TITLE ISSUED</b> - Vehicle color noted as Cream
10/16/2019	Iowa Motor Vehicle Dept. Spencer, IA	 <b>NOT ACTUAL MILEAGE TITLE ISSUED</b> - Vehicle color noted as Cream
11/04/2020	Iowa Motor Vehicle Dept. Spencer, IA	 <b>NOT ACTUAL MILEAGE TITLE ISSUED</b> - Vehicle color noted as Cream
09/07/2021	Iowa Motor Vehicle Dept. Spencer, IA	 <b>NOT ACTUAL MILEAGE TITLE ISSUED</b> - Vehicle color noted as Cream
08/30/2022	Iowa Motor Vehicle Dept. Spencer, IA	 <b>New owner reported</b> - <b>NOT ACTUAL MILEAGE TITLE ISSUED</b> - Vehicle color noted as Cream

08/11/2023	Iowa Motor Vehicle Dept. Spencer, IA	 <b>NOT ACTUAL MILEAGE TITLE ISSUED</b> - Vehicle color noted as Cream
05/02/2024	Iowa Motor Vehicle Dept. Spencer, IA	 <b>NOT ACTUAL MILEAGE TITLE ISSUED</b> - Vehicle color noted as Cream
08/15/2024	75,980 Frankman Motor Co., Inc. Sioux Falls, SD 605-250-8771 frankmanmotors.com ★ 4.7 / 5.0 115 Verified Reviews ❤️ 63 Customer Favorites	 <b>Vehicle serviced</b> - Tire condition and pressure checked - Vehicle washed/detailed - Oil and filter changed - Drive belts checked
08/23/2024	Frankman Motor Co., Inc. Sioux Falls, SD 605-250-8771 frankmanmotors.com/ ★ 4.7 / 5.0 115 Verified Reviews ❤️ 63 Customer Favorites	<b>Vehicle offered for sale</b>
11/28/2024	CARFAX Car Care	<b>Manufacturer Recommended Maintenance Schedules</b>



Get this vehicle's maintenance schedule, service history and recall alerts at [carfax.com/service](https://www.carfax.com/service).

Have Questions? Please visit our Help Center at [www.carfax.com](https://www.carfax.com).



## Glossary

### Accident Indicator

CARFAX receives information about accidents in all 50 states, the District of Columbia and Canada.

Not every accident is reported to CARFAX. As details about the accident become available, those additional details are added to the CARFAX Vehicle History Report. CARFAX recommends that you have this vehicle inspected by a qualified mechanic.

- According to the National Safety Council, Injury Facts, 2021 edition, 5% of the 276 million registered vehicles in the U.S. were involved in an accident in 2019. Over 77% of these were considered minor or moderate.
- This CARFAX Vehicle History Report is based only on information supplied to CARFAX and available as of 11/28/24 at 12:25:12 PM (CST). Other information about this vehicle, including problems, may not have been reported to CARFAX. Use this report as one important tool, along with a vehicle inspection and test drive, to make a better decision about your next used car.

### Damage Severity

Damage events result in one of the following severity levels:

- **Minor:** Generally, minor damage is cosmetic (including dents or scratches), may only require reconditioning, and typically does not compromise a vehicle's operation and/or safety.
- **Moderate:** Moderate damage may affect multiple components of the vehicle and may impair the vehicle's operation and/or safety.
- **Severe:** Severe damage usually affects multiple components of the vehicle and is likely to compromise the vehicle's operation and/or safety.

CARFAX recommends getting a pre-purchase inspection at a certified collision repair facility.

#### **Federal Odometer Act**

The Federal Odometer Act requires a seller to disclose the vehicle's mileage on the title when ownership is transferred. Congress enacted this Act to prohibit odometer tampering and to protect consumers from mileage fraud. Under this act, sellers must disclose any issues with the vehicle's odometer. These disclosures translate into the Exceed Mechanical Limits and Not Actual Mileage titles.

#### **First Owner**

When the first owner(s) obtains a title from a Department of Motor Vehicles as proof of ownership.

#### **New Owner Reported**

When a vehicle is sold to a new owner, the Title must be transferred to the new owner(s) at a Department of Motor Vehicles.

#### **Not Actual Mileage Title**

When the seller certifies, under the Federal Odometer Act, that the odometer reading does not reflect the vehicle's actual mileage. This may occur because the odometer was tampered with, broken, or replaced.

#### **Ownership History**

CARFAX defines an owner as an individual or business that possesses and uses a vehicle. Not all title transactions represent changes in ownership. To provide estimated number of owners, CARFAX proprietary technology analyzes all the events in a vehicle history. Estimated ownership is available for vehicles manufactured after 1991 and titled solely in the US including Puerto Rico. Dealers sometimes opt to take ownership of a vehicle and are required to in the following states: Maine, Massachusetts, New Jersey, Ohio, Oklahoma, Pennsylvania and South Dakota. Please consider this as you review a vehicle's estimated ownership history.

#### **Title Issued**

A state issues a title to provide a vehicle owner with proof of ownership. Each title has a unique number. Each title or registration record on a CARFAX report does not necessarily indicate a change in ownership. In Canada, a registration and bill of sale are used as proof of ownership.

**Follow Us:**



[facebook.com/CARFAX](https://facebook.com/CARFAX)



[@CARFAXinc](https://twitter.com/CARFAXinc)



[About CARFAX](#)

CARFAX DEPENDS ON ITS SOURCES FOR THE ACCURACY AND RELIABILITY OF ITS INFORMATION. THEREFORE, NO RESPONSIBILITY IS ASSUMED BY CARFAX OR ITS AGENTS FOR ERRORS OR OMISSIONS IN THIS REPORT. CARFAX FURTHER EXPRESSLY DISCLAIMS ALL WARRANTIES, EXPRESS OR IMPLIED, INCLUDING ANY IMPLIED WARRANTIES OF MERCHANTABILITY OR FITNESS FOR A PARTICULAR PURPOSE.

SYSTEMATIC RETRIEVAL OF THE CONTENT OR OTHER DATA FROM THIS SITE TO CREATE OR COMPILE, DIRECTLY OR INDIRECTLY, IN WHOLE OR IN PART, A COLLECTION, COMPILATION, DATABASE OR DIRECTORY WITHOUT THE EXPRESS WRITTEN PERMISSION OF CARFAX IS STRICTLY PROHIBITED. BY USING THE CARFAX VEHICLE HISTORY REPORT YOU AGREE TO THE CARFAX TERMS OF USE AND PRIVACY STATEMENT.

© 2024 CARFAX, Inc., part of S&P Global. All rights reserved.  
11/28/24 12:25:12 PM (CST)