



This report provided free of charge by:

Unlimited Auto Sales

2828 S State St
South Salt Lake, UT 84115

(801) 485-2584



Vehicle History Report™

US \$44.99

2008 NISSAN TITAN PRO-4X

VIN: 1N6AA07C08N325793
CREW PICKUP
5.6L V8 F DOHC 32V
GASOLINE
REAR WHEEL DRIVE W/ 4X4

This CARFAX Report Provided
by:
Unlimited Auto Sales

Accident reported: minor damage

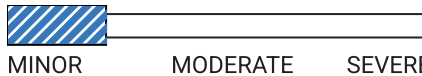

36 Service history records



At least 1 open recall



3 Previous owners



275,003 Last reported odometer reading



This CARFAX Vehicle History Report is based only on information supplied to CARFAX and available as of 2/11/25 at 6:26:26 PM (CST). Other information about this vehicle, including problems, may not have been reported to CARFAX. Use this report as one important tool, along with a vehicle inspection and test drive, to make a better decision about your next used car.



Accident / Damage History

Not all accidents / issues are reported to CARFAX

Event 1

01/03/2014

**Accident reported:
minor damage with
another motor vehicle**
- Airbags did not deploy

Damage Severity Scale

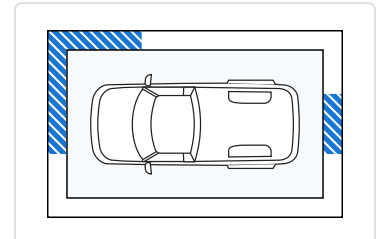
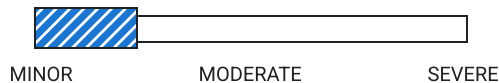

Event 2

12/28/2016

Damage reported: minor damage

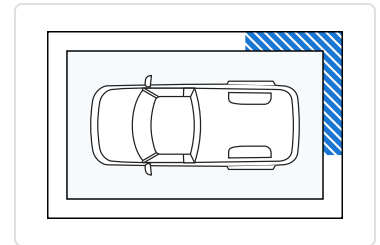
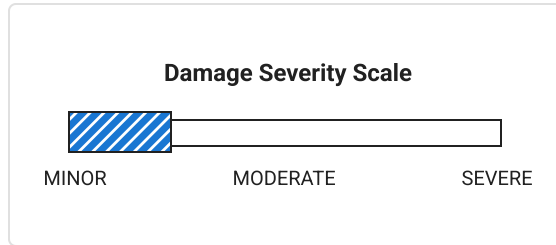

Event 3

04/05/2018

Accident reported: minor damage with another motor vehicle
- Airbags did not deploy

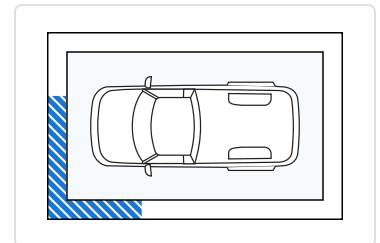
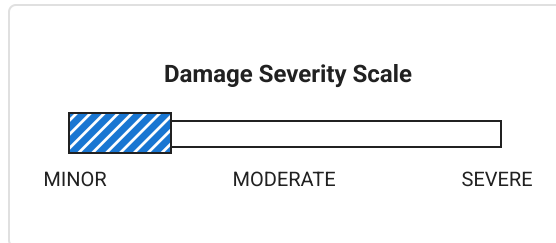

Event 4

05/21/2019

Accident reported: minor damage with another motor vehicle

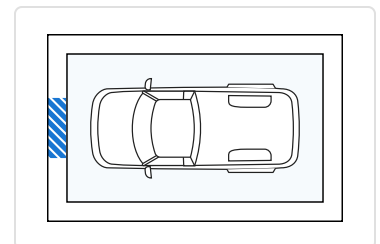
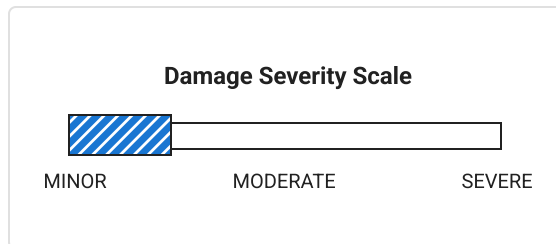



Additional History

Not all accidents / issues are reported to CARFAX





	Owner 1	Owner 2	Owner 3
Total Loss No total loss reported to CARFAX.	<input checked="" type="checkbox"/> No Issues Reported	<input checked="" type="checkbox"/> No Issues Reported	<input checked="" type="checkbox"/> No Issues Reported
Structural Damage CARFAX recommends that you have this vehicle inspected by a collision repair specialist.	<input checked="" type="checkbox"/> No Issues Reported	<input checked="" type="checkbox"/> No Issues Reported	<input checked="" type="checkbox"/> No Issues Reported
Airbag Deployment No airbag deployment reported to CARFAX.	<input checked="" type="checkbox"/> No Issues Reported	<input checked="" type="checkbox"/> No Issues Reported	<input checked="" type="checkbox"/> No Issues Reported
Odometer Check No indication of an odometer rollback.	<input checked="" type="checkbox"/> No Issues Indicated	<input checked="" type="checkbox"/> No Issues Indicated	<input checked="" type="checkbox"/> No Issues Indicated
Accident / Damage Accidents reported: 01/03/2014, 04/05/2018, and 05/21/2019. Damage reported: 12/28/2016.	Minor Damage	No New Issues Reported	No New Issues Reported

Manufacturer Recall At least 1 manufacturer recall requires service. Locate an authorized Nissan dealer near you to schedule an appointment.	<input checked="" type="checkbox"/> No Recalls Reported	Recall Reported	No New Recalls Reported
Basic Warranty Original warranty estimated to have expired.	Warranty Expired	Warranty Expired	Warranty Expired

 Title History CARFAX guarantees the information in this section	Owner 1	Owner 2	Owner 3
Damage Brands Salvage Junk Rebuilt Fire Flood Hail Lemon	<input checked="" type="checkbox"/> Guaranteed No Problem	<input checked="" type="checkbox"/> Guaranteed No Problem	<input checked="" type="checkbox"/> Guaranteed No Problem
Odometer Brands Not Actual Mileage Exceeds Mechanical Limits	<input checked="" type="checkbox"/> Guaranteed No Problem	<input checked="" type="checkbox"/> Guaranteed No Problem	<input checked="" type="checkbox"/> Guaranteed No Problem
 GUARANTEED - None of these title problems were reported by a U.S. state Department of Motor Vehicles (DMV). If you find that any of these title problems were reported by a DMV and not included in this report, you may qualify. View Terms View Certificate			

 Ownership History The number of owners is estimated	Owner 1	Owner 2	Owner 3
Year purchased	2007	2021	2024
Type of owner	Personal	Personal	Personal
Estimated length of ownership	13 yrs. 9 mo.	2 yrs. 11 mo.	5 months
Owned in the following states/provinces	Utah	Utah	Utah
Estimated miles driven per year	15,848/yr	---	---
Last reported odometer reading	218,757	275,003	---

 Detailed History			
 Owner 1 Purchased: 2007		Personal Vehicle 15,848 mi/yr	
Date	Mileage	Source	Comments
08/23/2007		NICB	Vehicle manufactured and shipped to Utah

09/17/2007	3	Ken Garff Nissan of Orem Orem, UT 801-225-1300 kengarffnissanorem.com ★ 4.4 / 5.0 182 Verified Reviews ❤️ 286 Customer Favorites	 Vehicle serviced - Pre-delivery inspection completed - VIN glass etching vin etched - Vehicle washed/detailed
10/03/2007		Ken Garff Nissan of Orem Orem, UT 801-225-1300 kengarffnissanorem.com ★ 4.4 / 5.0 182 Verified Reviews ❤️ 286 Customer Favorites	 Vehicle serviced - Accessories installed
10/27/2007	58	Ken Garff Nissan of Orem Orem, UT 801-225-1300 kengarffnissanorem.com ★ 4.4 / 5.0 182 Verified Reviews ❤️ 286 Customer Favorites	Vehicle sold
10/27/2007		Utah Motor Vehicle Dept. Orem, UT	Vehicle purchase reported - First owner reported - Titled or registered as personal vehicle
11/05/2007	429	Ken Garff Nissan of Orem Orem, UT 801-225-1300 kengarffnissanorem.com ★ 4.4 / 5.0 182 Verified Reviews ❤️ 286 Customer Favorites	 Vehicle serviced - Accessories installed
11/15/2007		Utah Motor Vehicle Dept. Orem, UT	Registration issued or renewed - Loan or lien reported - Passed safety inspection
12/20/2007	3,064	Ken Garff Nissan of Orem Orem, UT 801-225-1300 kengarffnissanorem.com ★ 4.4 / 5.0 182 Verified Reviews	 Vehicle serviced - Oil and filter changed

 **286** Customer Favorites

08/25/2008 17,906

Ken Garff Nissan of
Orem
Orem, UT
801-225-1300
kengarffnissanorem.com



Vehicle serviced

- Interior trim checked
- Noise checked
- Oil and filter changed

 **4.4 / 5.0**

182 Verified Reviews

 **286** Customer Favorites

10/10/2008 20,098

Ken Garff Nissan of
Orem
Orem, UT
801-225-1300
kengarffnissanorem.com



Vehicle serviced

 **4.4 / 5.0**

182 Verified Reviews

 **286** Customer Favorites

11/10/2008

Utah
Motor Vehicle Dept.
Orem, UT

Registration issued or renewed

- Passed safety inspection

12/20/2008 23,108

Ken Garff Nissan of
Orem
Orem, UT
801-225-1300
kengarffnissanorem.com



Vehicle serviced

- Body electrical system checked
- Brakes checked
- Drivability/performance checked
- Interior trim checked

 **4.4 / 5.0**

182 Verified Reviews

 **286** Customer Favorites

03/06/2009 23,110

Ken Garff Nissan of
Orem
Orem, UT
801-225-1300
kengarffnissanorem.com



Vehicle serviced

- Drivability/performance checked
- Drive belt tensioner replaced
- Drive belt(s) replaced

 **4.4 / 5.0**

182 Verified Reviews

 **286** Customer Favorites

11/04/2009

Utah
Motor Vehicle Dept.
Orem, UT

Registration issued or renewed

- Passed safety inspection

11/12/2009 41,650

Ken Garff Nissan of
Orem
Orem, UT
801-225-1300
kengarffnissanorem.com











Vehicle serviced

- Maintenance inspection completed
- Mud flaps/splash guards installed
- Tire condition and pressure checked

 **4.4 / 5.0**

182 Verified Reviews
 **286** Customer Favorites

12/10/2009	Utah Motor Vehicle Dept. Orem, UT		Registration updated when owner moved the vehicle to a new location
03/01/2010 48,773	Ken Garff Nissan of Orem Orem, UT 801-225-1300 kengarffnissanorem.com ★ 4.4 / 5.0 182 Verified Reviews  286 Customer Favorites		Vehicle serviced <ul style="list-style-type: none">- Maintenance inspection completed- Differential fluid flushed/changed- Differential serviced- Noise checked- Tire condition and pressure checked- Transmission fluid flushed
11/16/2010	Utah Motor Vehicle Dept. Orem, UT		Registration issued or renewed <ul style="list-style-type: none">- Passed safety inspection
01/11/2011 64,534	Ken Garff Nissan of Orem Orem, UT 801-225-1300 kengarffnissanorem.com ★ 4.4 / 5.0 182 Verified Reviews  286 Customer Favorites		Vehicle serviced <ul style="list-style-type: none">- Maintenance inspection completed- Cooling system checked- Electrical system checked- Engine oil/fluid leak checked- Fluids checked- Front differential pinion seal replaced- Fuel level sending unit replaced- Noise checked- Tire condition and pressure checked
04/25/2011 70,803	Ken Garff Nissan of Orem Orem, UT 801-225-1300 kengarffnissanorem.com ★ 4.4 / 5.0 182 Verified Reviews  286 Customer Favorites		Vehicle serviced <ul style="list-style-type: none">- Maintenance inspection completed- Noise checked- Tire condition and pressure checked
08/29/2011 78,696	Tim Dahle Nissan Southtowne Sandy, UT 801-495-3800 timdahlesandy.com ★ 4.1 / 5.0 1,117 Verified Reviews  12,293 Customer Favorites		Vehicle serviced <ul style="list-style-type: none">- Maintenance inspection completed- Oil and filter changed- Tire condition and pressure checked- Tires rotated
10/05/2011	Utah Motor Vehicle Dept. Orem, UT		Registration issued or renewed <ul style="list-style-type: none">- Loan or lien reported- Passed safety inspection

09/18/2012 99,308 Ken Garff Nissan of Orem
Orem, UT
801-225-1300
kengarffnissanorem.com
★ 4.4 / 5.0
182 Verified Reviews
♥ 286 Customer Favorites



Vehicle serviced

12/07/2012 Utah
Motor Vehicle Dept.
Orem, UT

Registration issued or renewed

- Loan or lien reported
- Passed safety inspection

11/12/2013 Utah
Motor Vehicle Dept.
Orem, UT

Registration issued or renewed

- Loan or lien reported
- Passed safety inspection
- Vehicle color noted as Gray

01/03/2014 Damage Report



Accident reported: minor damage with another motor vehicle

- Damage to right front
- Damage to front
- Damage to rear
- Airbags did not deploy



Damage Severity Scale

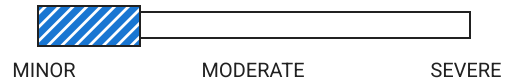

Damage Location

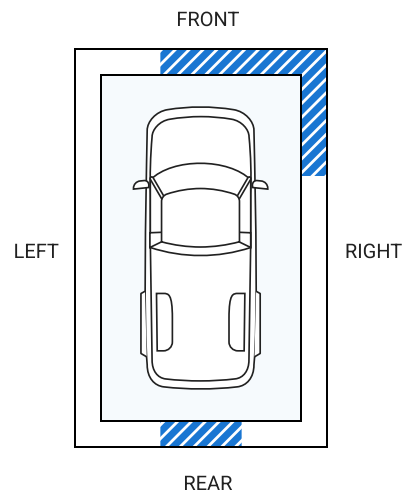

Minor damage is usually cosmetic, including dents or scratches to the vehicle body.

02/13/2014	117,904	Ken Garff Nissan of Orem Orem, UT 801-225-1300 kengarffnissanorem.com		Vehicle serviced - Maintenance inspection completed - Transmission mount(s) replaced
		★ 4.4 / 5.0 182 Verified Reviews ❤️ 286 Customer Favorites		
11/03/2014	131,978	Grease Monkey #805 Draper, UT 801-542-0366		Vehicle serviced - Emissions inspection performed - Oil and filter changed
		★ 4.5 / 5.0 116 Verified Reviews ❤️ 161 Customer Favorites		
11/03/2014	Utah Motor Vehicle Dept. Orem, UT		Registration issued or renewed - Loan or lien reported - Passed safety inspection - Vehicle color noted as Gray	
11/03/2015	Utah Motor Vehicle Dept. Orem, UT		Registration issued or renewed - Loan or lien reported - Passed safety inspection - Vehicle color noted as Gray	
12/31/2015	150,542	Ken Garff Nissan of Orem Orem, UT 801-225-1300 kengarffnissanorem.com		Vehicle serviced - Battery/charging system checked - No-start/hard start condition checked
		★ 4.4 / 5.0 182 Verified Reviews ❤️ 286 Customer Favorites		
10/17/2016	Utah Motor Vehicle Dept. Orem, UT		Registration issued or renewed - Loan or lien reported - Passed safety inspection - Vehicle color noted as Gray	
12/28/2016	Damage Report			Damage reported: minor damage - Damage to rear - Damage to right rear
<p style="text-align: center;">Damage Severity Scale</p> <p style="text-align: center;">MINOR MODERATE SEVERE</p>				
<p style="text-align: center;">Damage Location</p> <p style="text-align: center;">FRONT</p>				

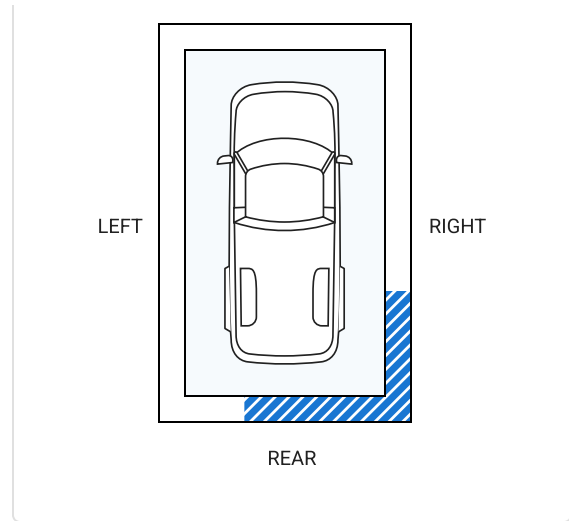

07/17/2017 179,622 Tim Dahle Nissan Southtowne Sandy, UT 801-495-3800 timdahlesandy.com

★ 4.1 / 5.0
1,117 Verified Reviews
♥ 12,293 Customer Favorites



Vehicle serviced

- Maintenance inspection completed
- Tire condition and pressure checked
- Transmission fluid flushed

11/03/2017 Utah Motor Vehicle Dept. Orem, UT

Registration issued or renewed

- Loan or lien reported
- Passed safety inspection
- Vehicle color noted as Gray

04/05/2018 Damage Report



Accident reported: minor damage with another motor vehicle

- Damage to left front
- Damage to front
- Airbags did not deploy

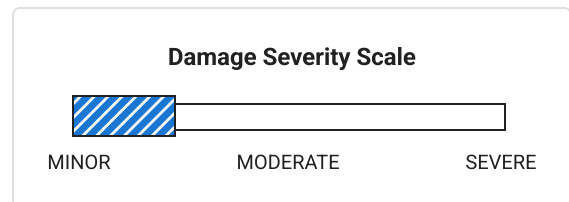

Damage Location
FRONT

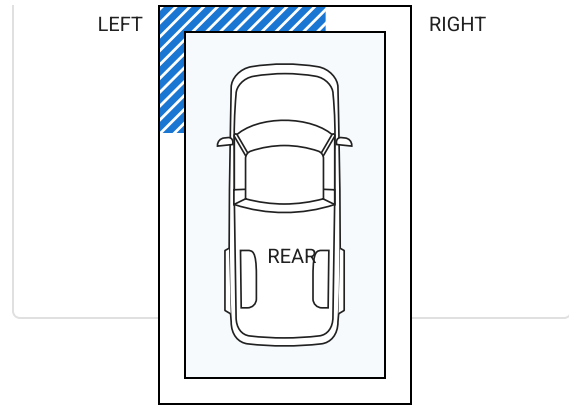

05/09/2018	189,537	Ken Garff Nissan Orem Orem, UT 801-225-1300 kengarffnissanorem.com /		Vehicle serviced - Maintenance inspection completed - Battery/charging system checked - Drivability/performance checked - Engine oil/fluid leak checked
		4.4 / 5.0 182 Verified Reviews 286 Customer Favorites		
05/18/2018	189,544	Ken Garff Nissan Orem Orem, UT 801-225-1300 kengarffnissanorem.com /		Vehicle serviced - Maintenance inspection completed - Battery/charging system checked - Drivability/performance checked - Key(s) (re) programmed
		4.4 / 5.0 182 Verified Reviews 286 Customer Favorites		
08/17/2018	192,723	Jiffy Lube Orem, UT 801-764-9500 jiffylube.com/ 3 Customer Favorites		Vehicle serviced - Oil and filter changed
11/12/2018	195,716	Jiffy Lube Lindon, UT 801-785-8097 jiffylube.com/		Vehicle serviced - Emissions inspection performed
11/12/2018	Utah Inspection Station		Passed emissions inspection	
11/12/2018	Utah Motor Vehicle Dept.		Registration issued or renewed - Loan or lien reported	

Orem, UT

- Passed safety inspection
- Vehicle color noted as Gray

12/06/2018 196,216 Ken Garff Nissan Orem
 Orem, UT
 801-225-1300
 kengarffnissanorem.com
 /



Vehicle serviced

- Maintenance inspection completed
- Battery/charging system checked
- Engine electrical system checked

★ 4.4 / 5.0

182 Verified Reviews

♥ 286 Customer Favorites

03/14/2019 197,825 Jiffy Lube
 Orem, UT
 801-764-9500
 jiffylube.com/
 ♥ 3 Customer Favorites



Vehicle serviced

- Oil and filter changed

05/21/2019 Damage Report



Accident reported: minor damage with another motor vehicle

- Damage to front

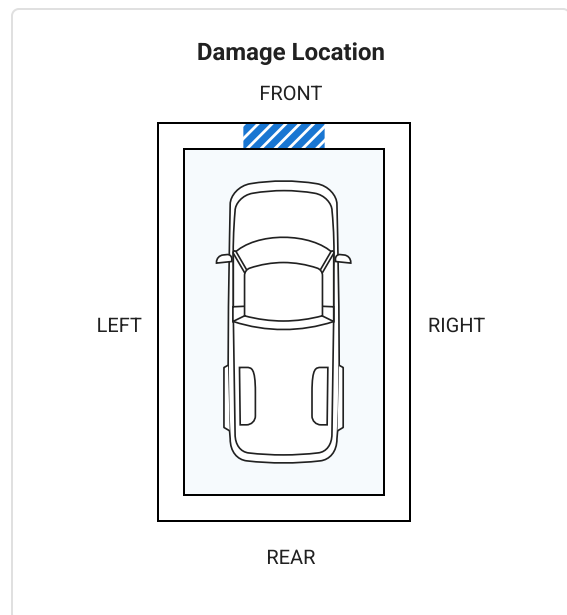
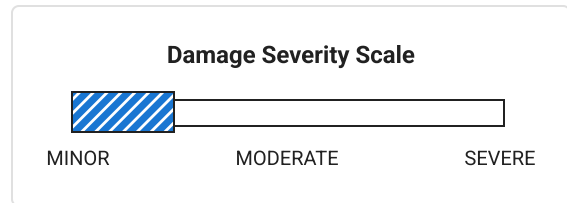















08/03/2019 202,326 Jiffy Lube
 Orem, UT
 801-764-9500
 jiffylube.com/
 ♥ 3 Customer Favorites



Vehicle serviced

- Oil and filter changed

10/21/2019	204,105	Jiffy Lube Orem, UT 801-764-9500 jiffylube.com/  3 Customer Favorites	 Vehicle serviced - Emissions inspection performed
10/21/2019		Utah Inspection Station	Passed emissions inspection
10/21/2019		Utah Motor Vehicle Dept. Orem, UT	Registration issued or renewed - Loan or lien reported - Passed safety inspection - Registration updated when owner moved the vehicle to a new location - Vehicle color noted as Gray
01/25/2020	207,255	Jiffy Lube Orem, UT 801-764-9500 jiffylube.com/  3 Customer Favorites	 Vehicle serviced - Air filter checked - Antifreeze/coolant checked - Brake fluid checked - Drive belts checked - Exterior lights checked - Fluids checked - Oil and filter changed - Tire condition and pressure checked - Wipers/washers checked
07/10/2020	211,013	Ken Garff Nissan Orem Orem, UT 801-225-1300 kengarffnissanorem.com /  4.4 / 5.0 182 Verified Reviews  286 Customer Favorites	 Vehicle serviced - Maintenance inspection completed - Battery/charging system checked - Undercoating/rustproofing applied
08/15/2020	212,338	Jiffy Lube Orem, UT 801-764-9500 jiffylube.com/  3 Customer Favorites	 Vehicle serviced - Oil and filter changed
03/06/2021	215,000	Ken Garff Nissan Orem Orem, UT 801-225-1300 kengarffnissanorem.com /  4.4 / 5.0 182 Verified Reviews  286 Customer Favorites	 Vehicle serviced - Maintenance inspection completed - Battery/charging system checked - Drivability/performance checked
03/06/2021		Jiffy Lube Orem, UT	 Vehicle serviced - Emissions inspection performed

801-764-9500
jiffylube.com/
 3 Customer Favorites

- Oil and filter changed

03/17/2021

Utah
Inspection Station

Passed emissions inspection

03/17/2021

Utah
Motor Vehicle Dept.
Orem, UT

Registration issued or renewed

- Loan or lien reported
- Passed safety inspection
- Vehicle color noted as Gray

05/19/2021 217,663



Jiffy Lube
Orem, UT
801-764-9500
jiffylube.com/
 3 Customer Favorites



Vehicle serviced

- Oil and filter changed

08/12/2021 218,757

Low Book Sales
Salt Lake City, UT
 4.7 / 5.0
128 Verified Reviews
 5 Customer Favorites

Vehicle offered for sale

08/16/2021

Utah
Inspection Station

Passed emissions inspection

 **Owner 2**
Purchased: 2021

Personal Vehicle

Date

Mileage

Source

Comments



08/16/2021

Utah
Motor Vehicle Dept.
Lehi, UT

Vehicle purchase reported

- Title or registration issued
- New owner reported
- Loan or lien reported
- Exempt from odometer reporting
- Vehicle color noted as Gray

11/19/2021 224,291

Grease Monkey - South
Jordan #987
South Jordan, UT
801-446-9653
greasemonkeysouthjordan987.com
 4.8 / 5.0
150 Verified Reviews
 71 Customer Favorites



Vehicle serviced

- Maintenance inspection completed
- Oil and filter changed
- Vehicle washed/detailed

02/04/2022 229,170

Grease Monkey - South
Jordan #987
South Jordan, UT
801-446-9653



Vehicle serviced



- Maintenance inspection completed
- Oil and filter changed
- Vehicle washed/detailed

greasemonkeysouthjordan987.com

★ 4.8 / 5.0

150 Verified Reviews

♥ 71 Customer Favorites

10/14/2022	Utah Inspection Station	Passed emissions inspection
10/14/2022	Utah Motor Vehicle Dept. Lehi, UT	Registration issued or renewed <ul style="list-style-type: none">- Loan or lien reported- Exempt from odometer reporting- Passed safety inspection- Vehicle color noted as Gray
02/09/2023	Nissan North America Inc.	Manufacturer Safety recall issued <ul style="list-style-type: none">- NHTSA #23E-012- Recall #PC947 ARM TTN DR AB EM NTB23-080- Status: Remedy Available <p>Locate an authorized Nissan dealer near you to obtain more information about this recall</p> <p>⊖ Learn more about this recall</p>
<div style="border: 1px solid blue; padding: 10px;"><p>Description: THE RESIN EMBLEM ON THE DRIVER S AIRBAG MODULE COVER IN AFFECTED VEHICLES MAY HAVE REDUCED DURABILITY DUE TO POTENTIAL SUPPLIER PRODUCTION PROCESS VARIATION. IN THIS CONDITION, OVER TIME THE POSTS OF THE EMBLEM MAY DEVELOP CRACKS, AND THE EMBLEM AND RETAINER COMPONENTS COULD DETACH IN THE EVENT OF AN AIRBAG DEPLOYMENT.</p><p>A DETACHED EMBLEM AND/OR RETAINER COMPONENT MAY BECOME A PROJECTILE DURING AN AIRBAG DEPLOYMENT, INCREASING THE RISK OF INJURY TO VEHICLE OCCUPANTS.</p><p>Remedy: Dealers will inspect and, if necessary, replace the Driver Airbag Cover.</p></div>		
01/30/2024	268,140 Jiffy Lube Lehi, UT 801-766-1914 jiffylube.com/ ♥ 1 Customer Favorite	 Vehicle serviced <ul style="list-style-type: none">- Emissions inspection performed
01/30/2024	Utah Inspection Station	Passed emissions inspection
01/30/2024	Utah Motor Vehicle Dept. Lehi, UT	Registration issued or renewed <ul style="list-style-type: none">- Exempt from odometer reporting- Passed safety inspection- Vehicle color noted as Gray
07/31/2024	275,003 Performance Emissions & Safety	 Vehicle serviced <ul style="list-style-type: none">- Emissions inspection performed

Salt Lake City, UT
801-466-5434

★ 4.7 / 5.0

131 Verified Reviews

♥ 2,144 Customer Favorites

08/14/2024

Utah
Inspection Station

Passed emissions inspection



Owner 3

Purchased: 2024

Personal Vehicle

Date	Mileage	Source	Comments
08/14/2024		Utah Motor Vehicle Dept. Lehi, UT	Vehicle purchase reported <ul style="list-style-type: none">- Title issued or updated- Correction to record- New owner reported- Exempt from odometer reporting- Vehicle color noted as Gray
08/22/2024		Utah Inspection Station	Passed emissions inspection
08/22/2024		Utah Motor Vehicle Dept. West Valley City, UT	Title or registration issued <ul style="list-style-type: none">- Loan or lien reported- Exempt from odometer reporting- Vehicle color noted as Gray
10/09/2024		Utah Motor Vehicle Dept. Salt Lake City, UT	Vehicle purchase reported <ul style="list-style-type: none">- Title issued or updated- Dealer took title of this vehicle while it was in inventory- Exempt from odometer reporting- Vehicle color noted as Gray
02/11/2025		CARFAX Car Care	Manufacturer Recommended Maintenance Schedules



Get this vehicle's maintenance schedule, service history and recall alerts at [carfax.com/service](https://www.carfax.com/service).

Have Questions? Please visit our Help Center at www.carfax.com.



Glossary

Accident Indicator

CARFAX receives information about accidents in all 50 states, the District of Columbia and Canada.

Not every accident is reported to CARFAX. As details about the accident become available, those additional details

are added to the CARFAX Vehicle History Report. CARFAX recommends that you have this vehicle inspected by a qualified mechanic.

- According to the National Safety Council, Injury Facts, 2021 edition, 5% of the 276 million registered vehicles in the U.S. were involved in an accident in 2019. Over 77% of these were considered minor or moderate.
- This CARFAX Vehicle History Report is based only on information supplied to CARFAX and available as of 2/11/25 at 6:26:26 PM (CST). Other information about this vehicle, including problems, may not have been reported to CARFAX. Use this report as one important tool, along with a vehicle inspection and test drive, to make a better decision about your next used car.

Damage Indicator

Damage can be a result of many different types of events. Examples include contact with objects (other cars, trees, traffic signs, road debris, etc), vandalism, or weather-related events. Not every damage event is reported to CARFAX. As details about the damage event become available, those additional details are added to the CARFAX Vehicle History Report. CARFAX recommends that you have this vehicle inspected by a qualified mechanic.

- This CARFAX Vehicle History Report is based only on information supplied to CARFAX and available as of 2/11/25 at 6:26:26 PM (CST). Other information about this vehicle, including problems, may not have been reported to CARFAX. Use this report as one important tool, along with a vehicle inspection and test drive, to make a better decision about your next used car.

Damage Severity

Damage events result in one of the following severity levels:

- Minor: Generally, minor damage is cosmetic (including dents or scratches), may only require reconditioning, and typically does not compromise a vehicle's operation and/or safety.
- Moderate: Moderate damage may affect multiple components of the vehicle and may impair the vehicle's operation and/or safety.
- Severe: Severe damage usually affects multiple components of the vehicle and is likely to compromise the vehicle's operation and/or safety.

CARFAX recommends getting a pre-purchase inspection at a certified collision repair facility.

First Owner

When the first owner(s) obtains a title from a Department of Motor Vehicles as proof of ownership.

Manufacturer Recall

Automobile manufacturers issue recall notices to inform vehicle owners of a safety defect or failure to meet minimum federal safety or emissions standards. Manufacturer recalls are repaired at no cost to the customer.

New Owner Reported

When a vehicle is sold to a new owner, the Title must be transferred to the new owner(s) at a Department of Motor Vehicles.

Ownership History

CARFAX defines an owner as an individual or business that possesses and uses a vehicle. Not all title transactions represent changes in ownership. To provide estimated number of owners, CARFAX proprietary technology analyzes all the events in a vehicle history. Estimated ownership is available for vehicles manufactured after 1991 and titled solely in the US including Puerto Rico. Dealers sometimes opt to take ownership of a vehicle and are required to in the following states: Maine, Massachusetts, New Jersey, Ohio, Oklahoma, Pennsylvania and South Dakota. Please consider this as you review a vehicle's estimated ownership history.

Title Issued

A state issues a title to provide a vehicle owner with proof of ownership. Each title has a unique number. Each title or registration record on a CARFAX report does not necessarily indicate a change in ownership. In Canada, a registration and bill of sale are used as proof of ownership.

Follow Us:  facebook.com/CARFAX

 [@CARFAXinc](https://twitter.com/CARFAXinc)

 [About CARFAX](#)

CARFAX DEPENDS ON ITS SOURCES FOR THE ACCURACY AND RELIABILITY OF ITS INFORMATION. THEREFORE, NO RESPONSIBILITY IS ASSUMED BY CARFAX OR ITS AGENTS FOR ERRORS OR OMISSIONS IN THIS REPORT. CARFAX FURTHER EXPRESSLY DISCLAIMS ALL WARRANTIES, EXPRESS OR IMPLIED, INCLUDING ANY IMPLIED WARRANTIES OF MERCHANTABILITY OR FITNESS FOR A PARTICULAR PURPOSE.

SYSTEMATIC RETRIEVAL OF THE CONTENT OR OTHER DATA FROM THIS SITE TO CREATE OR COMPILE, DIRECTLY OR INDIRECTLY, IN WHOLE OR IN PART, A COLLECTION, COMPILATION, DATABASE OR DIRECTORY WITHOUT THE EXPRESS WRITTEN PERMISSION OF CARFAX IS STRICTLY PROHIBITED. BY USING THE CARFAX VEHICLE HISTORY REPORT YOU AGREE TO THE CARFAX TERMS OF USE AND PRIVACY STATEMENT.

© 2025 CARFAX, Inc., part of S&P Global. All rights reserved.
2/11/25 6:26:26 PM (CST)