



This report provided free of charge by:

Select Jeeps

615 Highway 3 S
League City, TX 77573

866-921-5426

★ **3.4 / 5.0**

8 Verified Reviews



Vehicle History Report™

US \$44.99

2012 JEEP WRANGLER UNLIMITED SPORT

VIN: 1C4HJWDG4CL199017
4 DOOR WAGON/SPORT UTILITY
3.6L V6 F DOHC 24V GASOLINE
REAR WHEEL DRIVE W/ 4X4

This CARFAX Report Provided by:

Select Jeeps

★ **3.4 / 5.0**

8 Verified Reviews

Accident reported

27 Service history records

2 Previous owners

Personal vehicle

Last owned in Texas

156,458 Last reported odometer reading



This CARFAX Vehicle History Report is based only on information supplied to CARFAX and available as of 3/30/25 at 10:54:34 AM (CDT). Other information about this vehicle, including problems, may not have been reported to CARFAX. Use this report as one important tool, along with a vehicle inspection and test drive, to make a better decision about your next used car.



Accident / Damage History

Not all accidents / issues are reported to CARFAX

Event 1

07/02/2014

Accident reported

- Vehicle involved in a rear-end collision with another motor vehicle
- Airbags did not deploy

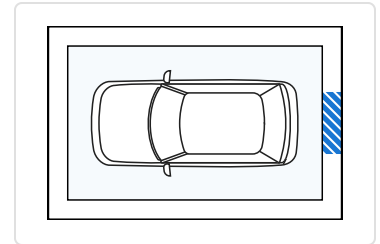

Event 2

06/23/2017

Accident reported: minor damage

- Vehicle involved in a rear-end collision
- Vehicle towed
- Airbags did not deploy

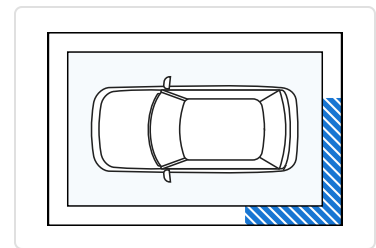
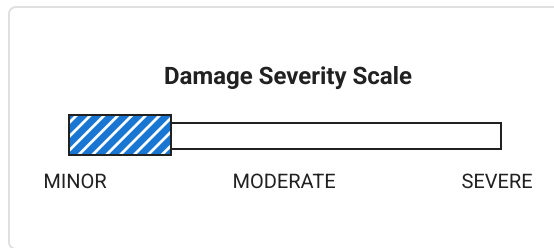

Event 3

08/30/2017

Accident reported: very minor damage

- Vehicle involved in a rear-end collision
- Airbags did not deploy

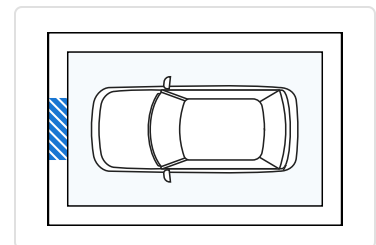
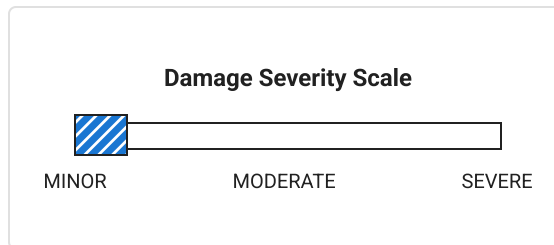

Additional History

Not all accidents / issues are reported to CARFAX

	Owner 1	Owner 2
Total Loss No total loss reported to CARFAX.	<input checked="" type="checkbox"/> No Issues Reported	<input checked="" type="checkbox"/> No Issues Reported
Structural Damage CARFAX recommends that you have this vehicle inspected by a collision repair specialist.	<input checked="" type="checkbox"/> No Issues Reported	<input checked="" type="checkbox"/> No Issues Reported
Airbag Deployment No airbag deployment reported to CARFAX.	<input checked="" type="checkbox"/> No Issues Reported	<input checked="" type="checkbox"/> No Issues Reported
Odometer Check No indication of an odometer rollback.	<input checked="" type="checkbox"/> No Issues Indicated	<input checked="" type="checkbox"/> No Issues Indicated
Accident / Damage Accidents reported: 07/02/2014, 06/23/2017, and 08/30/2017.	<input checked="" type="checkbox"/> No Issues Reported	Accident Reported
Manufacturer Recall No open recalls reported to CARFAX.	<input checked="" type="checkbox"/> No Recalls Reported	<input checked="" type="checkbox"/> No Recalls Reported
Basic Warranty Original warranty estimated to have expired.	Warranty Expired	Warranty Expired



Title History

CARFAX guarantees the information in this section

	Owner 1	Owner 2
Damage Brands Salvage Junk Rebuilt Fire Flood Hail Lemon	<input checked="" type="checkbox"/> Guaranteed No Problem	<input checked="" type="checkbox"/> Guaranteed No Problem

Odometer Brands

Not Actual Mileage | Exceeds Mechanical Limits

 **Guaranteed**
No Problem

 **Guaranteed**
No Problem



GUARANTEED - None of these title problems were reported by a U.S. state Department of Motor Vehicles (DMV). If you find that any of these title problems were reported by a DMV and not included in this report, you may qualify.
View Terms | View Certificate



Ownership History

The number of owners is estimated

Owner 1

Owner 2

Year purchased	2012	2013
Type of owner	Personal	Personal
Estimated length of ownership	8 months	11 yrs. 5 mo.
Owned in the following states/provinces	Georgia	Virginia, Texas
Estimated miles driven per year	---	12,835/yr
Last reported odometer reading	14,551	156,458



Detailed History





Owner 1

Purchased: 2012

Personal Vehicle

Date	Mileage	Source	Comments
02/21/2012	2	Neuwirth Motors Wilmington, NC 910-799-1815 neuwirthmotors.com ★ 4.3 / 5.0 221 Verified Reviews	Vehicle offered for sale
02/21/2012		Neuwirth Motors Wilmington, NC 910-799-1815 neuwirthmotors.com ★ 4.3 / 5.0 221 Verified Reviews	 Vehicle serviced - Pre-delivery inspection completed - Safety inspection performed
04/16/2012		Five Star Chrysler Dodge Jeep RAM Mazda of Macon Macon, GA 478-474-3700 fivestarcdr.com	Vehicle offered for sale

★ 4.1 / 5.0
 389 Verified Reviews
 ♥ 5,700 Customer Favorites

04/20/2012	13	Five Star Chrysler Dodge Jeep RAM Mazda of Macon Macon, GA 478-474-3700 fivestarcdr.com		Vehicle serviced - Vehicle washed/detailed
<p>★ 4.1 / 5.0 389 Verified Reviews ♥ 5,700 Customer Favorites</p>				
05/01/2012		Georgia Motor Vehicle Dept.		Vehicle purchase reported - Titled or registered as personal vehicle
05/03/2012	496	Five Star Chrysler Dodge Jeep RAM Mazda of Macon Macon, GA 478-474-3700 fivestarcdr.com		Vehicle sold
<p>★ 4.1 / 5.0 389 Verified Reviews ♥ 5,700 Customer Favorites</p>				
05/03/2012		Dealer Inventory		Vehicle offered for sale
05/22/2012		Georgia Motor Vehicle Dept. Yatesville, GA		Registration issued or renewed - Title or registration issued - First owner reported - Loan or lien reported - Vehicle color noted as Black
06/13/2012	3,073	Five Star Chrysler Dodge Jeep RAM Mazda of Macon Macon, GA 478-474-3700 fivestarcdr.com		Vehicle serviced
<p>★ 4.1 / 5.0 389 Verified Reviews ♥ 5,700 Customer Favorites</p>				
11/23/2012	11,244	Five Star Chrysler Dodge Jeep RAM Mazda of Macon Macon, GA 478-474-3700 fivestarcdr.com		Vehicle serviced

★ 4.1 / 5.0
 389 Verified Reviews
 ♥ 5,700 Customer Favorites

12/05/2012 11,708 Five Star Chrysler Dodge Jeep RAM Mazda of Macon
 Macon, GA
 478-474-3700
 fivestarcjdr.com



Vehicle serviced

★ 4.1 / 5.0
 389 Verified Reviews
 ♥ 5,700 Customer Favorites

12/28/2012 12,480 Five Star Chrysler Dodge Jeep RAM Mazda of Macon
 Macon, GA
 478-474-3700
 fivestarcjdr.com



Vehicle serviced

★ 4.1 / 5.0
 389 Verified Reviews
 ♥ 5,700 Customer Favorites

01/29/2013 14,185 Walsh Honda Macon, GA
 478-788-4510
 walshhonda.com

Vehicle offered for sale

★ 4.8 / 5.0
 967 Verified Reviews
 ♥ 7,760 Customer Favorites

02/02/2013 Walsh Honda Macon, GA
 478-788-4510
 walshhonda.com

Vehicle sold

★ 4.8 / 5.0
 967 Verified Reviews
 ♥ 7,760 Customer Favorites

02/04/2013 14,380 Dealer Inventory

Vehicle offered for sale

04/01/2013 14,418 Auto Auction

Vehicle sold



Millions of used vehicles are bought and sold at auction every year.

04/01/2013 Country Chevrolet

Vehicle offered for sale

Warrenton, VA
 540-905-4083
 countrychevrolet.com

04/05/2013	Dealer Inventory	Vehicle offered for sale
04/29/2013	Virginia Motor Vehicle Dept.	Vehicle purchase reported
04/30/2013	14,551 Virginia Inspection Station Reston, VA	Passed emissions inspection



Owner 2
 Purchased: 2013



Low mileage! This owner drove less than the industry average of 15,000 miles per year.

Personal Vehicle
 12,835 mi/yr

Date	Mileage	Source	Comments
05/28/2013		Virginia Motor Vehicle Dept. Vienna, VA	Registration issued or renewed - Title or registration issued - New owner reported - Loan or lien reported
04/30/2014		Virginia Inspection Station Reston, VA	Passed safety inspection - Passed emissions inspection
05/18/2014		Virginia Motor Vehicle Dept. Vienna, VA	Registration issued or renewed - Loan or lien reported
07/02/2014		Damage Report	 Accident reported - Vehicle involved in a rear-end collision with another motor vehicle - Damage to rear - Airbags did not deploy

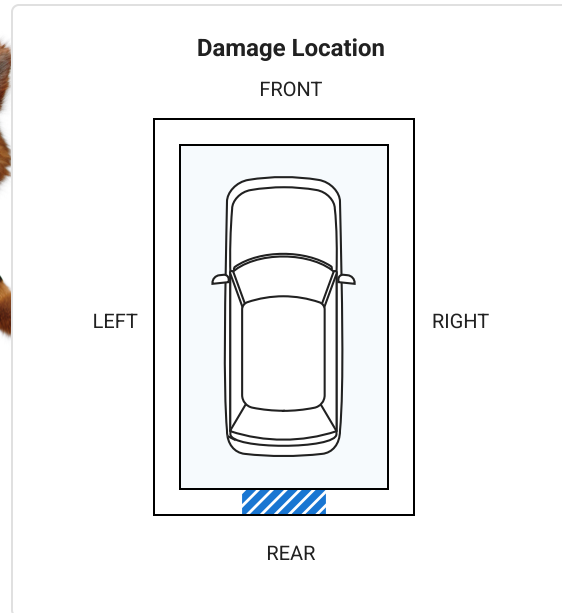

10/10/2014		Texas Motor Vehicle Dept. Desoto, TX		Registration issued or renewed - Loan or lien reported - Passed safety inspection - Registration updated when owner moved the vehicle to a new location - Vehicle color noted as Black
10/17/2014	27,224	Texas Motor Vehicle Dept. Desoto, TX		Odometer reading reported
05/06/2015	32,671	Kwik Kar Auto Repair Desoto, TX 972-223-2275		Vehicle serviced - Maintenance inspection completed - Oil and filter changed
10/01/2015		Texas Motor Vehicle Dept. Desoto, TX		Registration issued or renewed - Loan or lien reported - Passed safety inspection - Vehicle color noted as Black
11/19/2015	37,686	Kwik Kar Auto Repair Desoto, TX 972-223-2275		Vehicle serviced - Maintenance inspection completed - Oil and filter changed
04/02/2016	44,780	Kwik Kar Auto Repair Desoto, TX 972-223-2275		Vehicle serviced - Maintenance inspection completed - Oil and filter changed
08/24/2016	52,164	Kwik Kar Auto Repair Desoto, TX 972-223-2275		Vehicle serviced - Maintenance inspection completed - Oil and filter changed
10/04/2016	53,972	AutoNation CDJR Tyler Tyler, TX 877-414-7161		Vehicle serviced - Body electrical wiring repaired

autonationcdjrtyler.com

★ 4.3 / 5.0
19 Verified Reviews

- Emissions or safety inspection performed

10/05/2016

Texas
Motor Vehicle Dept.
Desoto, TX

Registration issued or renewed

- Loan or lien reported
- Passed safety inspection
- Vehicle color noted as Black

12/22/2016 55,911

Kwik Kar Auto Repair
Desoto, TX
972-223-2275



Vehicle serviced

- Maintenance inspection completed
- Oil and filter changed

06/23/2017

Damage Report



Accident reported: minor damage

- Vehicle involved in a rear-end collision
- Damage to left rear
- Damage to rear
- Vehicle towed
- Airbags did not deploy

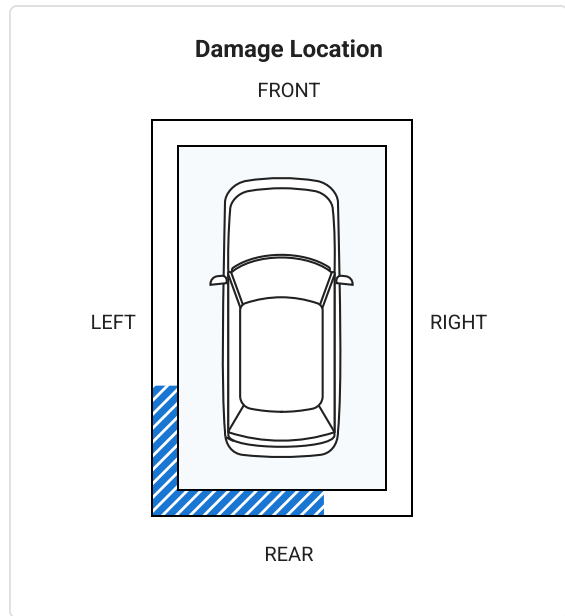
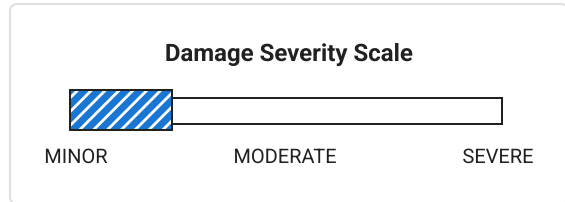

08/30/2017

Damage Report







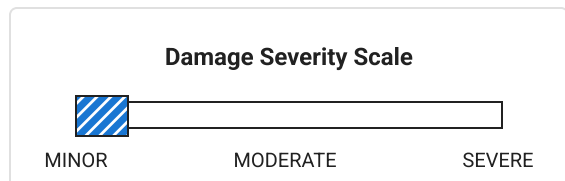

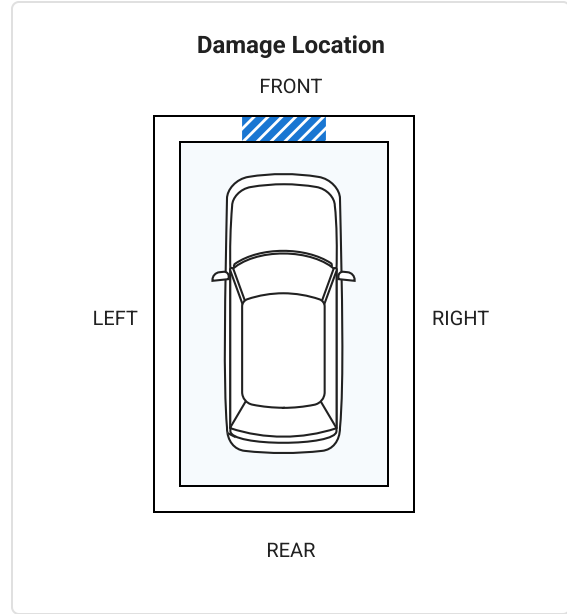
Accident reported: very minor damage





- Vehicle involved in a rear-end collision
- Damage to front
- Airbags did not deploy





09/30/2017	69,648	Texas Inspection Station	Passed safety inspection
10/01/2017		Texas Motor Vehicle Dept. Desoto, TX	Registration issued or renewed - Loan or lien reported - Passed safety inspection - Vehicle color noted as Black
12/27/2017	72,748	Ten Minute Oil Change #12 Desoto, TX 972-223-3100 ★ 4.7 / 5.0 129 Verified Reviews ♥ 53 Customer Favorites	 Vehicle serviced - Oil and filter changed
04/09/2018	76,558	Ten Minute Oil Change #12 Desoto, TX 972-223-3100 ★ 4.7 / 5.0 129 Verified Reviews ♥ 53 Customer Favorites	 Vehicle serviced - Oil and filter changed
05/22/2018	78,495	Waxahachie Dodge Chrysler Jeep RAM Waxahachie, TX 844-332-4664 waxahachiedodgechrysl rjeep.com ★ 4.4 / 5.0 356 Verified Reviews ♥ 118 Customer Favorites	 Vehicle serviced - Maintenance inspection completed

09/26/2018	82,416	Texas Inspection Station Desoto, TX	Failed emissions inspection
09/26/2018		Ten Minute Oil Change #12 Desoto, TX 972-223-3100 ★ 4.7 / 5.0 129 Verified Reviews ♥ 53 Customer Favorites	 Vehicle serviced - Oil and filter changed
09/29/2018	82,667	Texas Inspection Station Desoto, TX	Passed emissions inspection
10/01/2018		Texas Motor Vehicle Dept. Desoto, TX	Registration issued or renewed - Loan or lien reported - Passed safety inspection - Vehicle color noted as Black
10/02/2018		Waxahachie Dodge Chrysler Jeep RAM Waxahachie, TX 844-332-4664 waxahachiedodgechrysl rjeep.com ★ 4.4 / 5.0 356 Verified Reviews ♥ 118 Customer Favorites	 Vehicle serviced - Maintenance inspection completed
08/05/2019	90,382	Walmart Auto Care Center Mckinney, TX 972-542-4451 https://www.walmart.co m ★ 4.7 / 5.0 87 Verified Reviews	 Vehicle serviced - Oil and filter changed
09/16/2019	92,885	Ten Minute Oil Change #12 Desoto, TX 972-223-3100 ★ 4.7 / 5.0 129 Verified Reviews ♥ 53 Customer Favorites	 Vehicle serviced
09/16/2019		Texas Inspection Station Desoto, TX	Passed emissions inspection
10/01/2019		Texas	Registration issued or renewed

		Motor Vehicle Dept. Desoto, TX		- Loan or lien reported - Passed safety inspection - Vehicle color noted as Black
12/02/2019	98,662	Walmart Auto Care Center Mckinney, TX 972-542-4451 https://www.walmart.com ★ 4.7 / 5.0 87 Verified Reviews		Vehicle serviced - Oil and filter changed
09/04/2020	114,686	Ten Minute Oil Change #12 Desoto, TX 972-223-3100 ★ 4.7 / 5.0 129 Verified Reviews ❤️ 53 Customer Favorites		Vehicle serviced - Air filter replaced - Oil and filter changed
10/06/2020	116,259	Texas Inspection Station Desoto, TX		Passed emissions inspection
10/07/2020		Texas Motor Vehicle Dept. Desoto, TX		Registration issued or renewed - Loan or lien reported - Passed safety inspection - Vehicle color noted as Black
07/31/2021	134,841	Kwik Kar Lube and Services Frisco, TX 972-712-1188 ★ 4.6 / 5.0 67 Verified Reviews ❤️ 2 Customer Favorites		Vehicle serviced - Oil and filter changed
09/14/2021	135,631	Texas Inspection Station Desoto, TX		Passed emissions inspection
10/01/2021		Texas Motor Vehicle Dept. Desoto, TX		Registration issued or renewed - Loan or lien reported - Passed safety inspection - Vehicle color noted as Black
01/07/2022	140,696	Frisco Chrysler Dodge Jeep Ram Frisco, TX 469-888-4788 friscochryslerjeepdodgeram.com/		Vehicle serviced - Inspection performed - Maintenance inspection completed

★ 4.1 / 5.0

777 Verified Reviews

♥ 9,971 Customer Favorites

03/19/2022 142,928

Kwik Kar Lube and Services
Frisco, TX
972-712-1188**Vehicle serviced**

- Oil and filter changed

★ 4.6 / 5.0

67 Verified Reviews

♥ 2 Customer Favorites

06/30/2022 144,495

Marlow Automotive
Plano, TX
972-633-1299
autorepairplanotx.com**Vehicle serviced**- Maintenance inspection completed
- Water pump gasket replaced
- Water pump replaced

★ 4.9 / 5.0

62 Verified Reviews

♥ 301 Customer Favorites

10/14/2022 145,957

Marlow Automotive
Plano, TX
972-633-1299
autorepairplanotx.com**Vehicle serviced**- Maintenance inspection completed
- Antifreeze/coolant flushed/changed
- Radiator cap replaced

★ 4.9 / 5.0

62 Verified Reviews

♥ 301 Customer Favorites

11/02/2022 146,134

Texas
Inspection Station
Desoto, TX**Passed emissions inspection**

11/17/2022

Texas
Motor Vehicle Dept.
Desoto, TX**Registration issued or renewed**- Loan or lien reported
- Passed safety inspection
- Vehicle color noted as Black

08/14/2023 150,624

Texas
Inspection Station
Desoto, TX**Passed emissions inspection**

09/18/2023 152,068

Kwik Kar Lube & Tune
Mesquite, TX
972-288-5959**Vehicle serviced**- Maintenance inspection completed
- Oil and filter changed

★ 4.8 / 5.0

593 Verified Reviews

♥ 2,597 Customer Favorites

10/01/2023

Texas
Motor Vehicle Dept.
Desoto, TX**Registration issued or renewed**- Loan or lien reported
- Passed safety inspection

- Vehicle color noted as Black

09/17/2024	156,330	Texas Inspection Station Desoto, TX	Passed emissions inspection
10/01/2024		Texas Motor Vehicle Dept. Desoto, TX	Registration issued or renewed - Loan or lien reported - Passed safety inspection - Vehicle color noted as Black
11/08/2024	156,458	Online Listing	Vehicle offered for sale
11/13/2024		Auto Auction	Vehicle sold
11/15/2024		Select Jeeps League City, TX 281-338-1989 selectjeeps.com/ ★ 3.4 / 5.0 8 Verified Reviews	Vehicle offered for sale
11/18/2024		Auto Auction	Vehicle sold
12/31/2024		Select Jeeps League City, TX 281-338-1989 selectjeeps.com/ ★ 3.4 / 5.0 8 Verified Reviews	Vehicle offered for sale
03/30/2025		CARFAX Car Care	Manufacturer Recommended Maintenance Schedules



Get this vehicle's maintenance schedule, service history and recall alerts at [carfax.com/service](https://www.carfax.com/service).

Have Questions? Please visit our Help Center at www.carfax.com.



Glossary

Accident Indicator

CARFAX receives information about accidents in all 50 states, the District of Columbia and Canada.

Not every accident is reported to CARFAX. As details about the accident become available, those additional details are added to the CARFAX Vehicle History Report. CARFAX recommends that you have this vehicle inspected by a qualified mechanic.

- According to the National Safety Council, Injury Facts, 2021 edition, 5% of the 276 million registered vehicles in the U.S. were involved in an accident in 2019. Over 77% of these were considered minor or moderate.

- This CARFAX Vehicle History Report is based only on information supplied to CARFAX and available as of 3/30/25 at 10:54:34 AM (CDT). Other information about this vehicle, including problems, may not have been reported to CARFAX. Use this report as one important tool, along with a vehicle inspection and test drive, to make a better decision about your next used car.

Damage Severity

Damage events result in one of the following severity levels:

- Minor: Generally, minor damage is cosmetic (including dents or scratches), may only require reconditioning, and typically does not compromise a vehicle's operation and/or safety.
- Moderate: Moderate damage may affect multiple components of the vehicle and may impair the vehicle's operation and/or safety.
- Severe: Severe damage usually affects multiple components of the vehicle and is likely to compromise the vehicle's operation and/or safety.

CARFAX recommends getting a pre-purchase inspection at a certified collision repair facility.

Failed Emissions Inspection

The emissions check performed during a vehicle inspection indicated the vehicle was emitting more than allowable emissions standards and/or had missing or modified parts. Repeated failed emissions records can indicate engine problems and CARFAX recommends you have the vehicle inspected.

First Owner

When the first owner(s) obtains a title from a Department of Motor Vehicles as proof of ownership.

New Owner Reported

When a vehicle is sold to a new owner, the Title must be transferred to the new owner(s) at a Department of Motor Vehicles.

Ownership History

CARFAX defines an owner as an individual or business that possesses and uses a vehicle. Not all title transactions represent changes in ownership. To provide estimated number of owners, CARFAX proprietary technology analyzes all the events in a vehicle history. Estimated ownership is available for vehicles manufactured after 1991 and titled solely in the US including Puerto Rico. Dealers sometimes opt to take ownership of a vehicle and are required to in the following states: Maine, Massachusetts, New Jersey, Ohio, Oklahoma, Pennsylvania and South Dakota. Please consider this as you review a vehicle's estimated ownership history.

Follow Us:



[facebook.com/CARFAX](https://www.facebook.com/CARFAX)



[@CARFAXinc](https://twitter.com/CARFAXinc)



[About CARFAX](#)

CARFAX DEPENDS ON ITS SOURCES FOR THE ACCURACY AND RELIABILITY OF ITS INFORMATION. THEREFORE, NO RESPONSIBILITY IS ASSUMED BY CARFAX OR ITS AGENTS FOR ERRORS OR OMISSIONS IN THIS REPORT. CARFAX FURTHER EXPRESSLY DISCLAIMS ALL WARRANTIES, EXPRESS OR IMPLIED, INCLUDING ANY IMPLIED WARRANTIES OF MERCHANTABILITY OR FITNESS FOR A PARTICULAR PURPOSE.

SYSTEMATIC RETRIEVAL OF THE CONTENT OR OTHER DATA FROM THIS SITE TO CREATE OR COMPILE, DIRECTLY OR INDIRECTLY, IN WHOLE OR IN PART, A COLLECTION, COMPILATION, DATABASE OR DIRECTORY WITHOUT THE EXPRESS WRITTEN PERMISSION OF CARFAX IS STRICTLY PROHIBITED. BY USING THE CARFAX VEHICLE HISTORY REPORT YOU AGREE TO THE CARFAX TERMS OF USE AND PRIVACY STATEMENT.

© 2025 CARFAX, Inc., part of S&P Global. All rights reserved.
3/30/25 10:54:34 AM (CDT)