



This report provided free of charge by:

**Arlington Auto Group**

3621 Columbia Pike Ste 10  
Arlington, VA 22204

571-520-4283

★ **4.6 / 5.0**

8 Verified Reviews



# Vehicle History Report™

US \$44.99

## 2011 NISSAN XTERRA PRO-4X

VIN: 5N1AN0NW0BC513023  
4 DOOR WAGON/SPORT UTILITY  
4.0L V6 F DOHC 24V GASOLINE  
REAR WHEEL DRIVE W/ 4X4

This CARFAX Report Provided by:

**Arlington Auto Group**

★ **4.6 / 5.0**

8 Verified Reviews

### Damage reported: minor damage

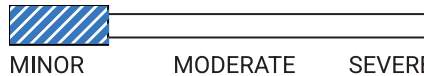

### 20 Service history records



At least 1 open recall



3 Previous owners



139,855 Last reported odometer reading



This CARFAX Vehicle History Report is based only on information supplied to CARFAX and available as of 4/21/25 at 11:00:09 AM (CDT). Other information about this vehicle, including problems, may not have been reported to CARFAX. Use this report as one important tool, along with a vehicle inspection and test drive, to make a better decision about your next used car.



## Accident / Damage History

Not all accidents / issues are reported to CARFAX

### Event 1

10/18/2013

**Damage reported: minor damage**

#### Damage Severity Scale

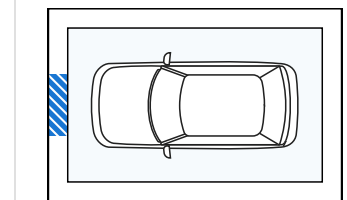
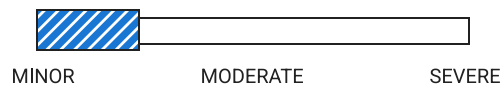

### Event 2

03/22/2016

**Damage reported: minor damage**

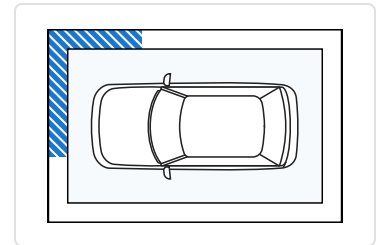
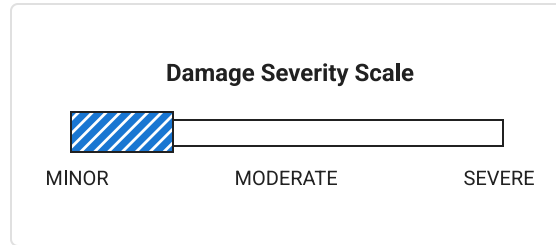







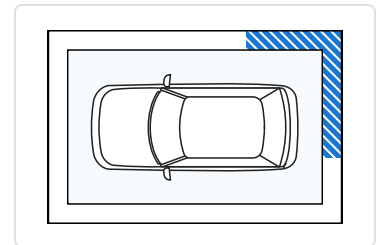
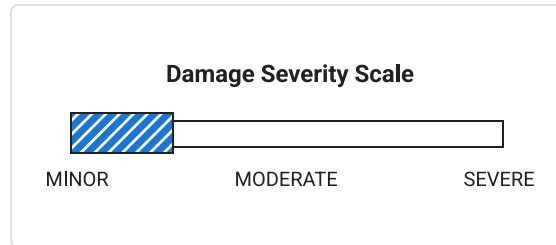

Event 3

12/20/2017

**Damage reported: minor damage**







 <b>Additional History</b> Not all accidents / issues are reported to CARFAX	Owner 1	Owner 2	Owner 3
<b>Total Loss</b> No total loss reported to CARFAX.	<input checked="" type="checkbox"/> No Issues Reported	<input checked="" type="checkbox"/> No Issues Reported	<input checked="" type="checkbox"/> No Issues Reported
<b>Structural Damage</b> CARFAX recommends that you have this vehicle inspected by a collision repair specialist.	<input checked="" type="checkbox"/> No Issues Reported	<input checked="" type="checkbox"/> No Issues Reported	<input checked="" type="checkbox"/> No Issues Reported
<b>Airbag Deployment</b> No airbag deployment reported to CARFAX.	<input checked="" type="checkbox"/> No Issues Reported	<input checked="" type="checkbox"/> No Issues Reported	<input checked="" type="checkbox"/> No Issues Reported
<b>Odometer Check</b> No indication of an odometer rollback.	<input checked="" type="checkbox"/> No Issues Indicated	<input checked="" type="checkbox"/> No Issues Indicated	<input checked="" type="checkbox"/> No Issues Indicated
<b>Accident / Damage</b> Damage reported: 10/18/2013, 03/22/2016, and 12/20/2017.	Minor Damage	Minor Damage	No New Issues Reported
<b>Manufacturer Recall</b> At least 1 manufacturer recall requires service. Locate an authorized Nissan dealer near you to schedule an appointment.	<input checked="" type="checkbox"/> No Recalls Reported	<input checked="" type="checkbox"/> No Recalls Reported	Recall Reported
<b>Basic Warranty</b> Original warranty estimated to have expired.	Warranty Expired	Warranty Expired	Warranty Expired

 <b>Title History</b> CARFAX guarantees the information in this section	Owner 1	Owner 2	Owner 3
<b>Damage Brands</b> Salvage   Junk   Rebuilt   Fire   Flood   Hail   Lemon	 <b>Guaranteed</b> No Problem	 <b>Guaranteed</b> No Problem	 <b>Guaranteed</b> No Problem
<b>Odometer Brands</b> Not Actual Mileage   Exceeds Mechanical Limits	 <b>Guaranteed</b> No Problem	 <b>Guaranteed</b> No Problem	 <b>Guaranteed</b> No Problem



**GUARANTEED** - None of these title problems were reported by a U.S. state Department of Motor Vehicles (DMV). If you find that any of these title problems were reported by a DMV and not included in this report, you may qualify.  
[View Terms](#) | [View Certificate](#)

 <b>Ownership History</b> The number of owners is estimated	Owner 1	Owner 2	Owner 3
Year purchased	2011	2014	2018
Type of owner	Personal	Lease	Personal
Estimated length of ownership	3 yrs. 6 mo.	3 years	6 yrs. 10 mo.
Owned in the following states/provinces	Pennsylvania	Pennsylvania	Pennsylvania
Estimated miles driven per year	21,477/yr	7,372/yr	5,830/yr
Last reported odometer reading	75,438	99,637	139,855

 <b>Detailed History</b>			
 <b>Owner 1</b> Purchased: 2011			Personal Vehicle 21,477 mi/yr
Date	Mileage	Source	Comments
02/28/2011		Antwerpen Volkswagen, Inc. Pasadena, MD 410-922-1700 antwerpenauto.com  <b>4.7 / 5.0</b> 490 Verified Reviews  <b>2,948</b> Customer Favorites	<b>Vehicle offered for sale</b>
02/28/2011	8	Antwerpen Security Nissan	 <b>Vehicle serviced</b> - Pre-delivery inspection completed



Gwynn Oak, MD  
410-298-4400  
antwerpensecuritynissan.com/

★ 4.4 / 5.0





353 Verified Reviews

♥ 365 Customer Favorites

- Nitrogen fill tires  
- Wheel locks installed

04/22/2011	Sheehy Auto Stores sheehy.com		<b>Vehicle offered for sale</b>
	★ 4.8 / 5.0 1,296 Verified Reviews ♥ 802 Customer Favorites		
05/30/2011 244	Pomoco Nissan Hampton, VA 757-838-6111 pomoconissan.com		<b>Vehicle sold</b>
	★ 4.6 / 5.0 345 Verified Reviews		
05/30/2011	Pennsylvania Motor Vehicle Dept.		<b>Vehicle purchase reported</b>
06/01/2011	Pomoco Chrysler of Hampton Hampton, VA 757-826-1100 pomocoauto.com		<b>Vehicle offered for sale</b>
	★ 4.4 / 5.0 195 Verified Reviews		
06/02/2011	Pomoco Nissan Hampton, VA 757-838-6111 pomoconissan.com		<b>Vehicle serviced</b> - Maintenance inspection completed - Emissions or safety inspection performed - Tire condition and pressure checked
	★ 4.6 / 5.0 345 Verified Reviews		
06/03/2011	Sheehy Auto Stores sheehy.com		<b>Vehicle sold</b>
	★ 4.8 / 5.0 1,296 Verified Reviews ♥ 802 Customer Favorites		
06/10/2011	Pennsylvania Motor Vehicle Dept. Bellefonte, PA		<b>Title issued or updated</b> - First owner reported - Titled or registered as personal vehicle - Loan or lien reported
06/13/2011 720	Nissan of State College State College, PA		<b>Vehicle serviced</b>

814-206-0901  
statecollegenissan.com/

06/28/2011	1,987	Inspection Station		<b>Passed emissions inspection</b>
08/01/2011		Pennsylvania Motor Vehicle Dept. Bellefonte, PA		<b>Registration issued or renewed</b>
08/08/2011	5,280	Pomoco Nissan Hampton, VA 757-838-6111 pomoconissan.com ★ 4.6 / 5.0 345 Verified Reviews		<b>Vehicle serviced</b> - Maintenance inspection completed - Drive belts checked - Fluids checked - Oil and filter changed - Tire condition and pressure checked
09/01/2011	6,591	Nissan of State College State College, PA 814-206-0901 statecollegenissan.com/		<b>Vehicle serviced</b> - Interior trim repaired
07/06/2012		Pennsylvania Motor Vehicle Dept. Bellefonte, PA		<b>Registration issued or renewed</b>
08/01/2012	24,983	Inspection Station		<b>Passed emissions inspection</b>
03/05/2013		Pennsylvania Motor Vehicle Dept. Wexford, PA		<b>Title issued or updated</b> - Registration updated when owner moved the vehicle to a new location
04/29/2013	40,881	Monro Auto Service & Tire Centers Altoona, PA ★ 4.7 / 5.0 34 Verified Reviews ❤️ 1 Customer Favorite		<b>Vehicle serviced</b> - Oil and filter changed - Tires rotated
07/10/2013	45,400	Monro Auto Service & Tire Centers Wexford, PA ★ 4.9 / 5.0 28 Verified Reviews		<b>Vehicle serviced</b> - Emissions inspection performed - Emissions or safety inspection performed
07/10/2013		Inspection Station		<b>Passed emissions inspection</b>
07/16/2013		Pennsylvania Motor Vehicle Dept. Wexford, PA		<b>Registration issued or renewed</b>
09/23/2013	49,161	Monro Auto Service & Tire Centers Altoona, PA ★ 4.7 / 5.0		<b>Vehicle serviced</b> - Oil and filter changed - Tires rotated

34 Verified Reviews

♥ 1 Customer Favorite

10/18/2013

Damage Report

**i** **Damage reported: minor damage**  
-Damage to front

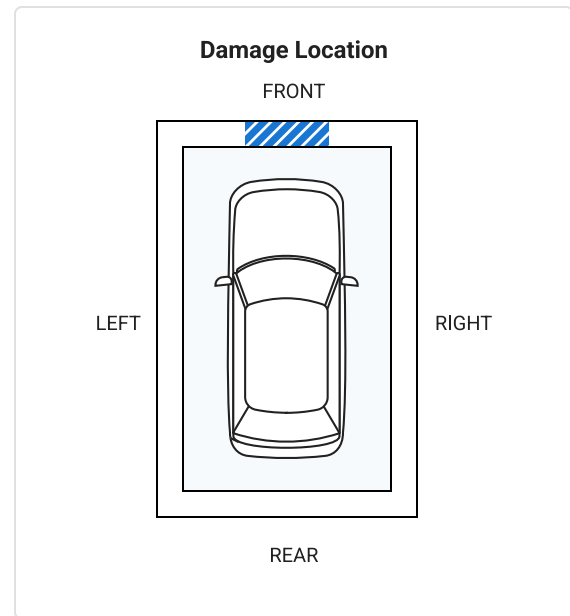
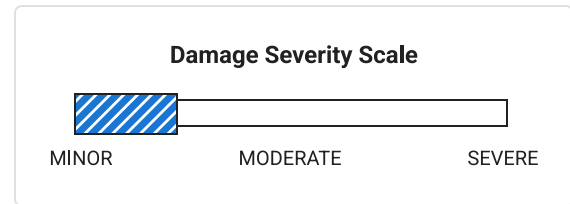

Minor damage is usually cosmetic, including dents or scratches to the vehicle body.

02/12/2014 56,281

Monro Auto Service & Tire Centers  
Wexford, PA

★ 4.9 / 5.0  
28 Verified Reviews



**Vehicle serviced**

- Brakes checked
- Brakes serviced
- Oil and filter changed
- Tires rotated

05/23/2014 62,827

Monro Auto Service & Tire Centers  
Wexford, PA

★ 4.9 / 5.0  
28 Verified Reviews



**Vehicle serviced**

- Oil and filter changed

06/02/2014 63,493



Inspection Station



**Passed emissions inspection**

06/19/2014

Pennsylvania Motor Vehicle Dept.  
Wexford, PA

**Registration issued or renewed**

12/02/2014	75,435	Courtesy Motor Sales Altoona, PA 814-942-9000 courtesyaltoona.net ★ 4.6 / 5.0 284 Verified Reviews ❤️ 851 Customer Favorites	<b>Vehicle offered for sale</b>
12/08/2014	75,437	Inspection Station	<b>Passed emissions inspection</b>
12/10/2014		Courtesy Motor Sales Altoona, PA 814-942-9000 courtesyaltoona.net ★ 4.6 / 5.0 284 Verified Reviews ❤️ 851 Customer Favorites	 <b>Vehicle serviced</b> - Pre-delivery inspection completed - Air filter replaced - Axle seal(s) replaced - Battery replaced - Brake rotor(s) replaced - Four wheel alignment performed - Front brake pads replaced - Front brake rotor(s) replaced - Key(s) (re) programmed - Rear brake pads replaced - Rear brake rotor(s) replaced - Windshield replaced
			<div style="border: 1px solid blue; padding: 5px;">                         Looks like this dealer serviced the car in order to prepare it for sale. That's a good thing!                     </div>
12/29/2014		Pennsylvania Motor Vehicle Dept.	<b>Vehicle purchase reported</b>
12/29/2014	75,438	Service Plan Co. Altoona, PA	<b>Service contract issued</b>

 <b>Owner 2</b> Purchased: 2014		<div style="border: 1px solid blue; padding: 5px;"> <b>Low mileage!</b> This owner drove less than the industry average of 15,000 miles per year.                 </div>	Lease Vehicle 7,372 mi/yr
---	---	--	------------------------------

Date	Mileage	Source	Comments
12/31/2014		Pennsylvania Motor Vehicle Dept. Altoona, PA	<b>Title issued or updated</b> - New owner reported

03/22/2016		Damage Report	 <b>Damage reported: minor damage</b> - Damage to front - Damage to right front
------------	--	---------------	--





MINOR                      MODERATE                      SEVERE

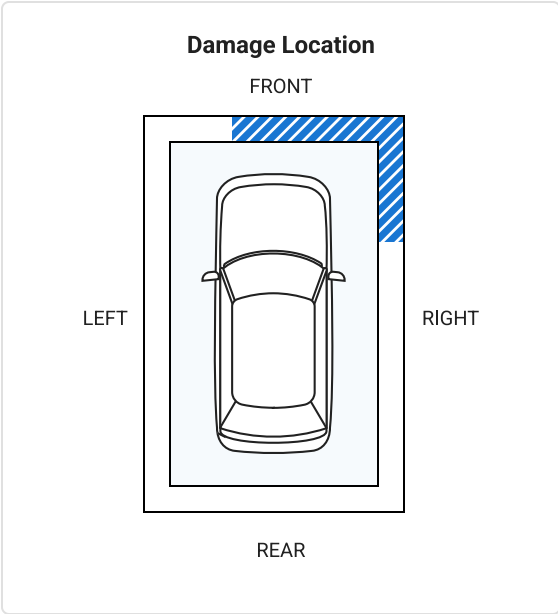

04/04/2016    86,477    Inspection Station

**Passed emissions inspection**

06/22/2017                      Nissan North America Inc.

**Manufacturer Service Campaign issued**  
- Campaign #P7318 TTN FNR XTR ACU MULTI TSB  
- Status: Remedy Available

Locate an authorized Nissan dealer near you to obtain more information about this campaign

[Learn more about this campaign](#)

**Description:** The current Air Bag Control Unit (ACU) rollover-sensing calibration logic could allow for unintended curtain air bag deployment in rare instances occurring under certain unique driving scenarios, usually involving unpaved roads or off-road where one side of the vehicle is higher than the other.

Failure to have the ACU reprogrammed in a timely manner could result in unintended rollover curtain air bag deployment. Customers should avoid driving off-road until the ACU software can be updated in their vehicle.

**Remedy:** Nissan is conducting a Voluntary Service Campaign to reprogram the ACU in 2004-2014 Titan, 2005-2014 Frontier, and 2005-2014 Xterra vehicles. Nissan authorized dealers will reprogram the ACU with updated software. The ACU reprogramming will improve rollover-sensing calibration to address certain unique driving scenarios, and help prevent unintended rollover curtain air bag deployment, while maintaining the design intent for deployment in rollover crashes. This service, which is conducted at no charge to you for parts and labor, should take approximately two (2) hours to complete. However, your Nissan dealer may require your vehicle for a longer period of time based upon their work schedule.

12/20/2017                      Damage Report



**Damage reported: minor damage**

- Damage to rear
- Damage to right rear



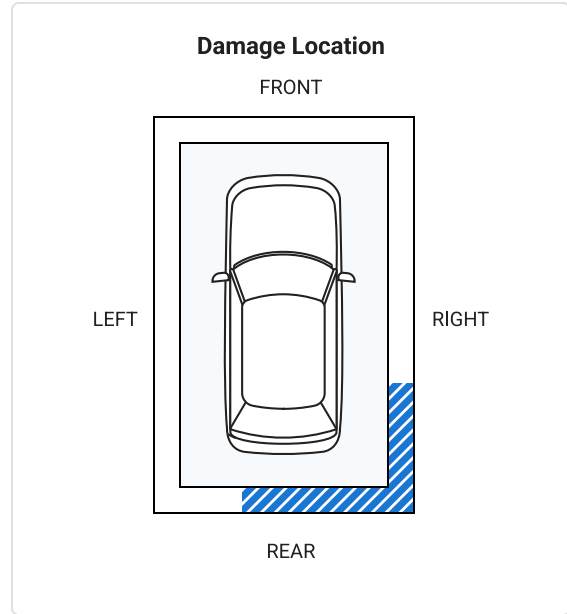
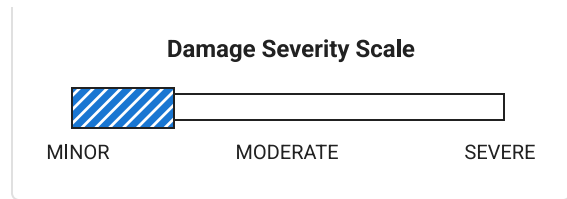

12/28/2017 99,454 Pennsylvania  
Motor Vehicle Dept.  
Getzville, NY

**Title issued or updated**  
- Titled or registered as lease vehicle



Two states? Vehicle leasing companies often title a car in one state but register it to be driven in another.

01/08/2018 99,485 Auto Auction

**Listed as a dealer vehicle**  
- Vehicle sold



Millions of used vehicles are bought and sold at auction every year.

01/19/2018 99,627 Inspection Station

**Passed emissions inspection**

01/22/2018 99,637 Five Star Mitsubishi  
Altoona  
Altoona, PA  
814-942-1447  
fivestarmitsubishialtoona.com



**Vehicle serviced**  
- Four wheel alignment performed

★ 4.8 / 5.0  
740 Verified Reviews  
♥ 4,986 Customer Favorites



**Owner 3**

Purchased: 2018



**Low mileage!** This owner drove less than the industry average of 15,000 miles per year.

Personal Vehicle  
5,830 mi/yr

Date	Mileage	Source	Comments
03/19/2018	99,760	Pennsylvania Motor Vehicle Dept.	<b>Vehicle purchase reported</b>
03/20/2018		Pennsylvania Motor Vehicle Dept. Central City, PA	<b>Title issued or updated</b> - New owner reported - Loan or lien reported
07/26/2018	104,145	Walmart Auto Care Center Johnstown, PA 814-266-0282 <a href="https://www.walmart.com">https://www.walmart.com</a>  ★ 4.4 / 5.0 28 Verified Reviews	 <b>Vehicle serviced</b> - Oil and filter changed
01/13/2019		Pennsylvania Motor Vehicle Dept. Montrose, PA	<b>Title issued or updated</b> - Registration issued or renewed - Registration updated when owner moved the vehicle to a new location
03/03/2021		Pennsylvania Motor Vehicle Dept. Montrose, PA	<b>Registration issued or renewed</b>
11/08/2021		Lia Nissan of Saratoga Ballston Spa, NY 518-886-4800 <a href="http://lianissansaratoga.com/">lianissansaratoga.com/</a>  ★ 4.6 / 5.0 193 Verified Reviews ❤️ 1,682 Customer Favorites	 <b>Inspection performed</b>
02/03/2022	127,573	Kost Tire and Auto Montrose, PA 570-278-4557  ★ 4.9 / 5.0 75 Verified Reviews ❤️ 21 Customer Favorites	 <b>Vehicle serviced</b> - Emissions or safety inspection performed
02/09/2023		Nissan North America Inc.	<b>Manufacturer Safety recall issued</b> - NHTSA #23E-012 - Recall #PC948 PTH FTR XTR AB EMB NTB-23-08 - Status: Remedy Available



Locate an authorized Nissan dealer near you to obtain more information about this recall

 **Learn more about this recall**

**Description:** THE RESIN EMBLEM ON THE DRIVER S AIRBAG MODULE COVER IN AFFECTED VEHICLES MAY HAVE REDUCED DURABILITY DUE TO POTENTIAL SUPPLIER PRODUCTION PROCESS VARIATION. IN THIS CONDITION, OVER TIME THE POSTS OF THE EMBLEM MAY DEVELOP CRACKS, AND THE EMBLEM AND RETAINER COMPONENTS COULD DETACH IN THE EVENT OF AN AIRBAG DEPLOYMENT.









A DETACHED EMBLEM AND/OR RETAINER COMPONENT MAY BECOME A PROJECTILE DURING AN AIRBAG DEPLOYMENT, INCREASING THE RISK OF INJURY TO VEHICLE OCCUPANTS.

**Remedy:** Dealers will inspect and, if necessary, replace the Driver Airbag Cover.

03/02/2023		Pennsylvania Motor Vehicle Dept. Montrose, PA		<b>Title issued or updated</b> -Registration issued or renewed
05/09/2023	133,290	Kost Tire and Auto Montrose, PA 570-278-4557 ★ 4.9 / 5.0 75 Verified Reviews ♥ 21 Customer Favorites		<b>Vehicle serviced</b> -Emissions or safety inspection performed -Muffler replaced -Tailpipe replaced -Tie rod end(s) replaced -Tire condition and pressure checked
02/28/2024		Pennsylvania Motor Vehicle Dept. Montrose, PA		<b>Registration issued or renewed</b>
06/14/2024	137,620	Shawnee Boys Garage Montrose, PA 570-278-9652 napaonline.com/en/auto care/?facilityid=657492 ♥ 1 Customer Favorite		<b>Vehicle serviced</b> -Emissions or safety inspection performed -Lower ball joint(s) replaced
01/06/2025		Shawnee Boys Garage Montrose, PA 570-278-9652 napaonline.com/en/auto care/?facilityid=657492 ♥ 1 Customer Favorite		<b>Vehicle serviced</b> -One tire mounted -Tire pressure monitoring system checked -Tire(s) mounted
01/29/2025	139,820	Tunkhannock Auto Mart Tunkhannock, PA 570-836-2266 tunkhannockautomart.net/ ★ 4.5 / 5.0		<b>Vehicle offered for sale</b>

353 Verified Reviews

 **2,926** Customer Favorites

01/31/2025	Tunkhannock Auto Mart Tunkhannock, PA 570-836-2266 tunkautomart.com		<b>Vehicle serviced</b>
	<p> <b>4.5 / 5.0</b>                  353 Verified Reviews   <b>2,926</b> Customer Favorites</p>		
02/07/2025	Online Listing		<b>Vehicle offered for sale</b>
02/11/2025	Auto Auction		<b>Vehicle sold</b>
02/18/2025	Arlington Auto Group Arlington, VA 703-271-2000 arlingtonautogroup.net/		<b>Vehicle offered for sale</b>
	<p> <b>4.6 / 5.0</b>                  8 Verified Reviews</p>		
03/19/2025	139,855	Virginia Inspection Station	<b>Passed safety inspection</b>
04/16/2025	Ashu Auto Repair and Body Shop Arlington, VA 571-970-4180		<b>Vehicle serviced</b> - Safety inspection performed
	<p> <b>4.8 / 5.0</b>                  43 Verified Reviews   <b>1</b> Customer Favorite</p>		
04/21/2025	CARFAX Car Care		<b>Manufacturer Recommended                  Maintenance Schedules</b>
			Get this vehicle's maintenance schedule, service history and recall alerts at <a href="https://www.carfax.com/service">carfax.com/service</a> .

# Check Availability

 (571) 520-4283



**Hi, I'm interested in this car**

Used 2011 Nissan Xterra PRO-4X

\$8,655 | 139,820 mi

## Your Contact Information

Add a personal note (optional)

By using this site, you agree to the use of cookies and other unique identifiers (collectively, "cookies"). You can opt out of optional cookies [here](#).

Got It

Have Questions? Please visit our Help Center at [www.carfax.com](http://www.carfax.com).



## Glossary

### Damage Indicator

Damage can be a result of many different types of events. Examples include contact with objects (other cars, trees, traffic signs, road debris, etc), vandalism, or weather-related events. Not every damage event is reported to CARFAX. As details about the damage event become available, those additional details are added to the CARFAX Vehicle History Report. CARFAX recommends that you have this vehicle inspected by a qualified mechanic.

- This CARFAX Vehicle History Report is based only on information supplied to CARFAX and available as of 4/21/25 at 11:00:09 AM (CDT). Other information about this vehicle, including problems, may not have been reported to CARFAX. Use this report as one important tool, along with a vehicle inspection and test drive, to make a better decision about your next used car.

### Damage Severity

Damage events result in one of the following severity levels:

- Minor: Generally, minor damage is cosmetic (including dents or scratches), may only require reconditioning, and typically does not compromise a vehicle's operation and/or safety.
- Moderate: Moderate damage may affect multiple components of the vehicle and may impair the vehicle's operation and/or safety.
- Severe: Severe damage usually affects multiple components of the vehicle and is likely to compromise the vehicle's operation and/or safety.

CARFAX recommends getting a pre-purchase inspection at a certified collision repair facility.

### First Owner

When the first owner(s) obtains a title from a Department of Motor Vehicles as proof of ownership.

### Lease

When someone leases a car from a dealer, the dealer actually sells the vehicle to a leasing company. The leasing company then collects payments for the vehicle from the new owner for 24, 36, 48 or more months. A leasing company can be an independent car dealer or a car manufacturer.

### Manufacturer Recall

Automobile manufacturers issue recall notices to inform vehicle owners of a safety defect or failure to meet minimum federal safety or emissions standards. Manufacturer recalls are repaired at no cost to the customer.

### New Owner Reported

When a vehicle is sold to a new owner, the Title must be transferred to the new owner(s) at a Department of Motor Vehicles.

### Ownership History

CARFAX defines an owner as an individual or business that possesses and uses a vehicle. Not all title transactions represent changes in ownership. To provide estimated number of owners, CARFAX proprietary technology analyzes all the events in a vehicle history. Estimated ownership is available for vehicles manufactured after 1991 and titled solely in the US including Puerto Rico. Dealers sometimes opt to take ownership of a vehicle and are required to in the following states: Maine, Massachusetts, New Jersey, Ohio, Oklahoma, Pennsylvania and South Dakota. Please consider this as you review a vehicle's estimated ownership history.

### Service Campaign

Automobile manufacturers issue a service campaign to address product technical issues that may not be related to safety or emissions standards. These issues are typically customer satisfaction initiatives.

### Title Issued

A state issues a title to provide a vehicle owner with proof of ownership. Each title has a unique number. Each title or registration record on a CARFAX report does not necessarily indicate a change in ownership. In Canada, a registration and bill of sale are used as proof of ownership.

Follow Us:



[facebook.com/CARFAX](https://www.facebook.com/CARFAX)



[@CARFAXinc](https://twitter.com/CARFAXinc)



About CARFAX

CARFAX DEPENDS ON ITS SOURCES FOR THE ACCURACY AND RELIABILITY OF ITS INFORMATION. THEREFORE, NO RESPONSIBILITY IS ASSUMED BY CARFAX OR ITS AGENTS FOR ERRORS OR OMISSIONS IN THIS REPORT. CARFAX FURTHER EXPRESSLY DISCLAIMS ALL WARRANTIES, EXPRESS OR IMPLIED, INCLUDING ANY IMPLIED WARRANTIES OF MERCHANTABILITY OR FITNESS FOR A PARTICULAR PURPOSE.

SYSTEMATIC RETRIEVAL OF THE CONTENT OR OTHER DATA FROM THIS SITE TO CREATE OR COMPILE, DIRECTLY OR INDIRECTLY, IN WHOLE OR IN PART, A COLLECTION, COMPILATION, DATABASE OR DIRECTORY WITHOUT THE EXPRESS WRITTEN PERMISSION OF CARFAX IS STRICTLY PROHIBITED. BY USING THE CARFAX VEHICLE HISTORY REPORT YOU AGREE TO THE CARFAX TERMS OF USE AND PRIVACY STATEMENT.

© 2025 CARFAX, Inc., part of S&P Global. All rights reserved.

4/21/25 11:00:09 AM (CDT)